

Anchor Systems

Hilti. Outperform. Outlast.





Introduction

Application overview for chemical anchors	Page 88-89
Application overview for mechanical anchors	Page 90-91



Adhesive anchors

Injectable mortar HIT-RE 500	Page 92
Injectable mortar HIT-RE 200-R	Page 93
Injectable mortar HIT-HY 70	Page 94
Injectable mortar HIT-MM PLUS	Page 95
Adhesive capsule anchor system HVU-TZ	Page 96
Adhesive capsule anchor system HVU	Page 97
Anchor rods	Page 98-101



Accessories for adhesive anchors

Dispensers and cartridge holders	Page 102-103
Blow out pump	Page 104
Mixers and extensions	Page 104
Setting tools	Page 104-105



Undercut anchors

Undercut anchor HDA-T	Page 106-111
Safety anchor HSC	Page 112-115



Expansion anchors

Heavy-duty anchor HSL	Page 116-118
Safety stud anchor HST	Page 119-120
Standard stud anchor HSA	Page 121-123
Standard stud anchor HSV	Page 124
Drop-in anchor HKD	Page 125-126
Sleeve stud anchor HKV	Page 127
Sleeve anchor HLC	Page 128
Sleeve anchor HLV	Page 129



Light-duty anchors

Frame anchor HRD-C	Page 130
Impact anchor HPS	Page 131
Universal plastic anchor HUD	Page 132
Cavity anchor HHD	Page 133
Light-duty anchor Kwik Tog HLD	Page 134



Accessories for mechanical anchor







Stop drill bits and settings tools	Page 135-137
Torque bar S-TB	Page 137



Anchor channels

Anchor channels HAC	Page 138-142
T-head bolts HBC	Page 143-147

Application overview for chemical anchors















Chemical anchors			
Anchor specification			
	Order description	Highlights	Dimensions
	HIT-RE 500 HAS-E Rod Rebar	Large diameter applications, suitable for dry and water saturated concrete and underwater applications, long working time at elevated temperatures, deep embedment depths and suitable for use in diamond drilled holes	M8-M39 HAS-E T8-T40 Rebar
	HIT-HY 200 HIT-Z Rod HAS-E Rod Rebar	No borehole cleaning required (when used with HIT-Z), suitable for dry and water saturated concrete, suitable for use in diamond drilled holes, fast cure	M8-M20 HIT-Z M8-M30 HAS-E T8-T32 Rebar
	HIT-HY 70 HAS-E Rod	Specially designed for masonry including clay bricks, sand lime bricks, hollow bricks, concrete blocks and natural stone	M8-M12 HAS-E
	HIT-MM PLUS HAS-E Rod Rebar	Suitable for a wide range of base materials including concrete, masonry and concrete blocks	M8-M16 HAS-E T8-T16 HAS-E
	HVU-TZ HAS-TZ Rod	Very high loading capacity suitable for dry and water saturated concrete	M10-M20 HAS-TZ
	HVU HAS-E Rod	Very high loading capacity, large diameter applications, suitable for dry and water saturated concrete	M8-M39 HAS-E

Base material								Installation method		Special features		Corrosion protection			Approvals					
Uncracked concrete	Cracked concrete	Natural stone	Lightweight concrete	Solid brick	Airbrick	Hollowcore	Plasterboard	Through set installation	Pre-set installation	Small edge distance	Data available in PROFIS Anchor 2	Electroplated	Hot-dipped galvanized	Stainless steel	Fire	Shock load	Sprinkler	European technical approval	Dynamic load	CE Marking

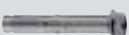
Anchor applications / approvals

Anchor	Uncracked concrete	Cracked concrete	Natural stone	Lightweight concrete	Solid brick	Airbrick	Hollowcore	Plasterboard	Through set installation	Pre-set installation	Small edge distance	Data available in PROFIS Anchor 2	Electroplated	Hot-dipped galvanized	Stainless steel	Fire	Shock load	Sprinkler	European technical approval	Dynamic load	CE Marking
Anchor 1	■									■	■	■	■	■	■						
Anchor 2	■	■								■	■	■	■	■	■						
Anchor 3					■	■	■	■		■	■	■	■	■	■						
Anchor 4	■					■				■	■	■	■	■	■						
Anchor 5	■	■								■	■	■	■	■	■						
Anchor 6	■									■	■	■	■	■	■						

Application overview for mechanical anchors

Mechanical anchors			
Anchor specification			
	Order description	Highlights	Dimensions
	HDA	Automatic undercutting with no special tools, setting mark for setting control, completely removable	M10-M20
	HSC	Self cutting undercut, low embedment depth	M6-M12
	HSL-3	Force controlled expansion, reliable pull down, no rotation in hole when tightening bolt	M8-M24
	HST	Safety wedge for follow up expansion	M8-M24
	HSA	3 different embedment depths, approved for diamond drilled holes	M6-M20
	HSV	Cold formed to prevent breaking during installation	M8-M16
	HKD	Protruding lip and setting mark for reliable setting	M6-M20
	HKV	Setting mark for reliable setting	1/4"-1/2"
	HLC	Permanent and temporary fastening in light and medium load range	M5-M16
	HLV	Permanent and temporary fastening for formwork, rack systems, rails, ladder etc	M6-M12
	HRD-C	Excellent setting behaviour, versatile with regards base material and finishes	10 mm
	HPS-1	Impact and temperature resistant	5-8 mm
	HUD-1	Excellent setting behaviour suitable for a wide range of base materials. Available with screw	5-12 mm
	HHD-S	Specially designed for drywall	M6
	HLD	Plastic undercut	10 mm

Base material								Installation method		Special features		Corrosion protection			Approvals					
Uncracked concrete	Cracked concrete	Natural stone	Lightweight concrete	Solid brick	Hollow block	Hollowcore	Plasterboard / Drywall	Through set installation	Pre-set installation	Small edge distance	Data available in calculation software (PROFIS Anchor)	Electroplated	Hot-dipped galvanized	Stainless steel	Fire	Shock load	Sprinkler	European technical approval	Dynamic load	CE Marking

Anchor applications / approvals

<input checked="" type="checkbox"/>	<input checked="" type="checkbox"/>							<input checked="" type="checkbox"/>	<input checked="" type="checkbox"/>	<input checked="" type="checkbox"/>	<input checked="" type="checkbox"/>	<input checked="" type="checkbox"/>	<input checked="" type="checkbox"/>	<input checked="" type="checkbox"/>						
<input checked="" type="checkbox"/>	<input checked="" type="checkbox"/>								<input checked="" type="checkbox"/>	<input checked="" type="checkbox"/>	<input checked="" type="checkbox"/>	<input checked="" type="checkbox"/>		<input checked="" type="checkbox"/>						
<input checked="" type="checkbox"/>	<input checked="" type="checkbox"/>							<input checked="" type="checkbox"/>	<input checked="" type="checkbox"/>		<input checked="" type="checkbox"/>	<input checked="" type="checkbox"/>								
<input checked="" type="checkbox"/>	<input checked="" type="checkbox"/>							<input checked="" type="checkbox"/>	<input checked="" type="checkbox"/>		<input checked="" type="checkbox"/>	<input checked="" type="checkbox"/>		<input checked="" type="checkbox"/>						
<input checked="" type="checkbox"/>								<input checked="" type="checkbox"/>	<input checked="" type="checkbox"/>		<input checked="" type="checkbox"/>	<input checked="" type="checkbox"/>	<input checked="" type="checkbox"/>	<input checked="" type="checkbox"/>						
<input checked="" type="checkbox"/>								<input checked="" type="checkbox"/>	<input checked="" type="checkbox"/>			<input checked="" type="checkbox"/>								
<input checked="" type="checkbox"/>									<input checked="" type="checkbox"/>		<input checked="" type="checkbox"/>	<input checked="" type="checkbox"/>		<input checked="" type="checkbox"/>						
<input checked="" type="checkbox"/>									<input checked="" type="checkbox"/>			<input checked="" type="checkbox"/>								
<input checked="" type="checkbox"/>				<input checked="" type="checkbox"/>				<input checked="" type="checkbox"/>	<input checked="" type="checkbox"/>			<input checked="" type="checkbox"/>								
<input checked="" type="checkbox"/>				<input checked="" type="checkbox"/>				<input checked="" type="checkbox"/>	<input checked="" type="checkbox"/>			<input checked="" type="checkbox"/>								
<input checked="" type="checkbox"/>			<input checked="" type="checkbox"/>	<input checked="" type="checkbox"/>				<input checked="" type="checkbox"/>	<input checked="" type="checkbox"/>			<input checked="" type="checkbox"/>								
<input checked="" type="checkbox"/>			<input checked="" type="checkbox"/>	<input checked="" type="checkbox"/>	<input checked="" type="checkbox"/>			<input checked="" type="checkbox"/>	<input checked="" type="checkbox"/>			<input checked="" type="checkbox"/>								
<input checked="" type="checkbox"/>			<input checked="" type="checkbox"/>	<input checked="" type="checkbox"/>	<input checked="" type="checkbox"/>		<input checked="" type="checkbox"/>	<input checked="" type="checkbox"/>	<input checked="" type="checkbox"/>			<input checked="" type="checkbox"/>								
							<input checked="" type="checkbox"/>		<input checked="" type="checkbox"/>			<input checked="" type="checkbox"/>								
					<input checked="" type="checkbox"/>		<input checked="" type="checkbox"/>		<input checked="" type="checkbox"/>											

Injectable mortar HIT-RE 500



Base materials

- Concrete (uncracked)

Applications

- Structural connections with post-installed rebar (e.g. extension/ connection to walls, slabs, stairs, columns, foundations, etc.)
- Substitution of misplaced/missing rebars or couplers
- Anchoring structural steel connections (e.g. steel columns, beams, etc.)
- Structural renovation of buildings, bridges and other civil structures. Retrofitting and re-strengthening of concrete members possible
- Suitable for underwater use in hammer-drilled holes
- Anchoring secondary steel structures (e.g. balustrades, steel ledgers, etc)

Advantages

- High performance and technical superiority as per international approvals
- Especially suitable for use with large-diameter elements and/or deep embedment depths
- No expansion forces in concrete allow secure fastenings even close to edges and/or with close spacing
- Unique foil packaging and compatible Hilti HIT injection system makes handling extremely easy
- Foil pack for minimized disposal costs due to less wastage
- Works like cast-in with post-installed rebars

Technical data

Material composition	Epoxy adhesive
Tested/approved for diamond drilling	Yes
PROFIS	Yes
Storage and transportation temperature - max.	25 °C
Base material condition	Dry, submerged, wet

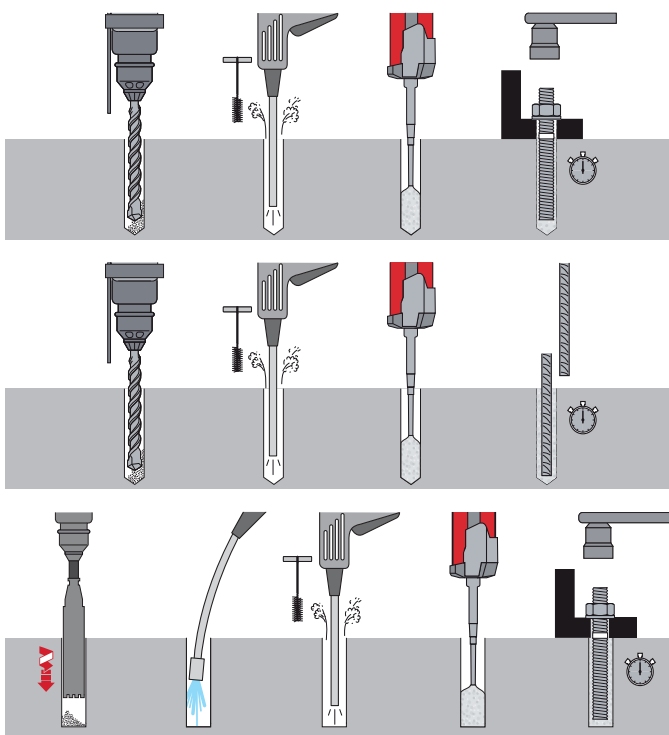

Ordering designation	Package contents	Sales pack quantity	Item number
HIT-RE 500/330/1 INT	1x 330ml Foil pack, 1x Mixer, 1x Mixer extension	1	426675
HIT-RE 500/500/1 INT	1x 500ml Foil pack, 1x Mixer, 1x Mixer extension	1	426672

Injectable mortar HIT-HY 200-R



Base materials

- Concrete (cracked)
- Concrete (uncracked)

Applications

- Anchoring structural steel connections (e.g. steel columns, beams)
- Structural renovation / upgrades with post-installed rebars
- Anchoring railings / safety barriers
- Anchoring secondary steel structures (e.g. staircases, steel ledgers)
- Substitution of misplaced / missing rebars
- Structural connections with post-installed rebars

Advantages

- No hole cleaning required with the revolutionary new HIT-Z anchor rod
- Curing time optimized for rebar applications and for deep anchoring applications
- Suitable for use in cracked and uncracked concrete with all anchor rods and rebars
- Highest approved loads according to latest international standards
- Works like cast-in in with post-installed rebars

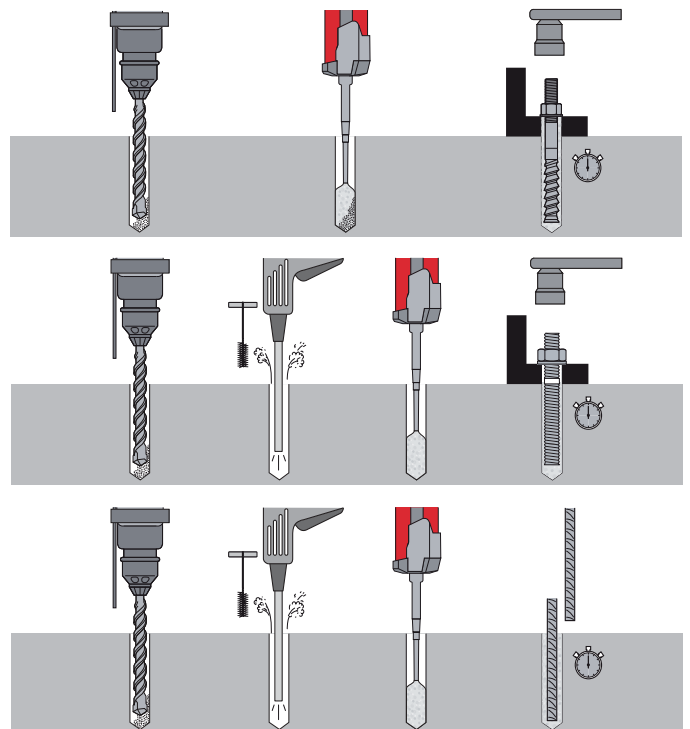
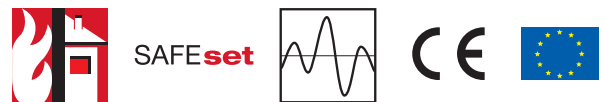

Technical data

SAFEset	Yes
Material composition	Hybrid urethane methacrylate adhesive
PROFIS	Yes
Storage and transportation temperature - max.	25 °C
Base material condition	Dry, wet
Cleaning procedures	Compressed-air cleaning, manual cleaning, no cleaning required with Hilti HIT-Z rod

Ordering designation	Package contents	Sales pack quantity	Item number
HIT-HY 200-R 330/2/EE	1x 330ml Foil pack, 2x Mixer, 1x Mixer extension	1	2045036
HIT-HY 200-R 500/2/EE	1x 500ml Foil pack, 2x Mixer, 1x Mixer extension	1	2045032

Anchor Systems

Injectable mortar HIT-HY 70



Base materials

- Concrete (aerated)
- Concrete (uncracked)
- Drywall
- Glass
- Masonry (hollow)
- Masonry (solid)
- Some types of natural stone

Applications

- Applications in hollow and solid masonry
- Suitable for glass structures
- For heavy bracing on insulated materials in applications such as the installation of sun shades
- For wall ties
- Refurbishment and renovation

Advantages

- For strong, reliable and easy-to-install fastenings in a variety of masonry materials
- Performs reliably where the quality of brick and mortar is inconsistent, even when the size and location of voids are unknown
- Fastenings are free of expansion forces and have technical approvals
- For indoor and outdoor applications, as well as for use in dry and wet drilled holes
- Can be used in the temperature range between -5°C and +40° C (except in solid brick)

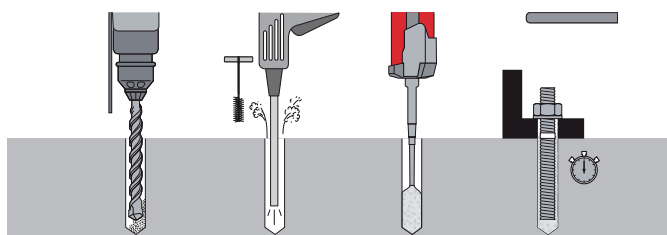

Technical data

Material composition	Hybrid urethane methacrylate adhesive
PROFIS	No
Storage and transportation temperature - max.	25 °C
Base material condition	Dry, wet
Cleaning procedures	Compressed-air cleaning, manual cleaning

Ordering designation	Package contents	Sales pack quantity	Item number
HIT-HY 70 330/2	1x 330ml Foil pack, 2x Mixer, 1x Mixer extension	1	383677

Injectable mortar HIT-MM PLUS



Base materials

- Concrete (aerated)
- Concrete (uncracked)
- Drywall
- Masonry (hollow)
- Masonry (solid)
- Some types of natural stone

Applications

- Wide range of fastening applications in the medium load range in hollow block, solid block and concrete where no approval is required
- Fence and railing posts, gates, window grills, non-structural re-bars, wall cabinets, bathroom fittings, air conditioning systems, lights
- Surface treatment
- Suitable for frequent, repetitive use

Advantages

- Easy dispensing thanks to well-proven manual, cordless and pneumatic dispensers
- Unique soft foil pack for less waste
- Contains no styrene or other blacklisted substances and is virtually odorless
- Partly-used cartridges can be reused after a break simply by fitting a new mixing nozzle (partly-used cartridges have to be re-used within 4 weeks)
- Suitable for use on all base materials

Technical data

Material composition	Hybrid urethane methacrylate adhesive
PROFIS	No
Storage and transportation temperature - max.	25 °C
Base material condition	Dry, wet
Cleaning procedures	Manual cleaning

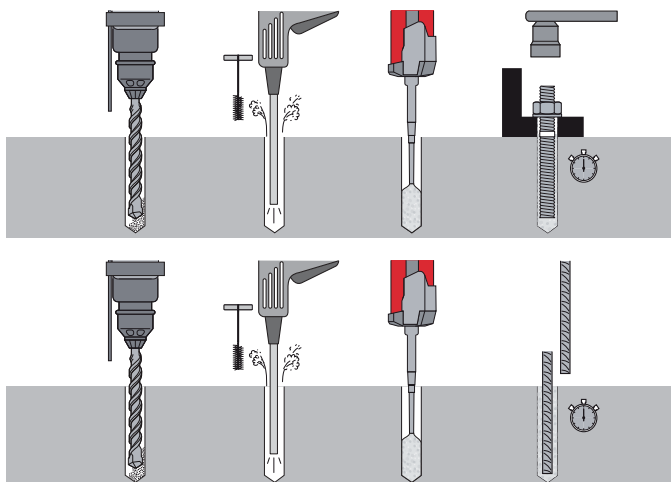

Anchor Systems

Ordering designation	Package contents	Sales pack quantity	Item number
HIT-MM PLUS 330/2	1x 330ml Foil pack, 2x Mixer, 1x Mixer extension	1	2031079
HIT-MM PLUS 500/2	1x 500ml Foil pack, 2x Mixer, 1x Mixer extension	1	2031400

Adhesive capsule anchor system HVU-TZ



Base materials

- Concrete (cracked)
- Concrete (uncracked)

Applications

- Heavy-duty fastenings in cracked concrete and for dynamic loading (steel structures, machinery, crash barriers and noise barriers, curtain wall facades, railings)
- For safety-relevant fastenings

Advantages

- Tested according to the standard temperature curve (ISO 834) and German tunnel temperature curve (ZTV-ING, part 5)
- Flexibility is the key
- Suitable for use in cracked concrete

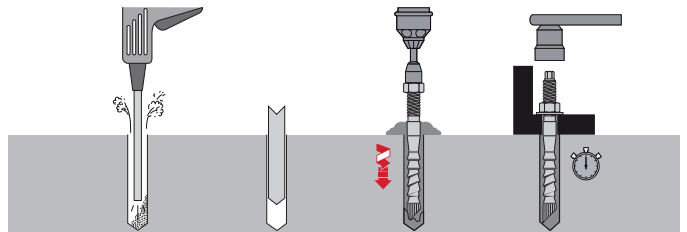
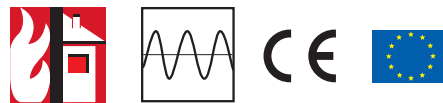

Technical data

Material composition	Hybrid urethane methacrylate adhesive
PROFIS	Yes
Storage and transportation temperature - max.	25 °C
Base material condition	Dry, wet
Anchoring elements	HAS-TZ torque-controlled bonded anchor

Ordering designation	Drill bit diameter	Standard embedment depth	Sales pack quantity	Item number
HVU-TZ M10	12 mm	75 mm	10	311368
HVU-TZ M12	14 mm	95 mm	10	311369
HVU-TZ M16	18 mm	105 mm	10	311370
HVU-TZ M20	25 mm	170 mm	4	335942

Adhesive capsule anchor system HVU



Base materials

- Concrete (uncracked)

Applications

- Anchoring structural steel connections (e.g. steel columns, beams, etc.)
- For anchor applications along roads and in tunnels (crash and noise barriers, overhead catenary systems)

Advantages

- Flexible foil capsule instead of glass: a robust product for tough jobsite conditions
- Tested according to standard temperature curve (ISO 834) and the German tunnel temperature curve (ZTV-ING, part 5)
- One system for many applications thanks to a wide range of adhesive capsules, anchor rods in various diameters and lengths
- Convenient for overhead applications
- Preportioned foil, no waste
- Styrene free, almost odourless

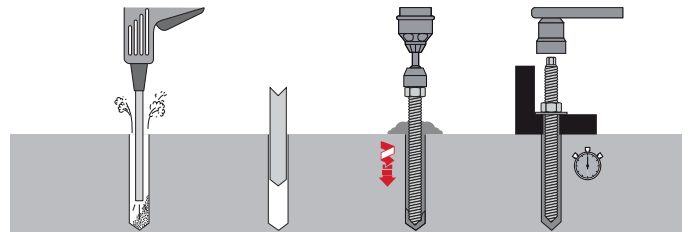

Technical data

Material composition	Hybrid urethane methacrylate adhesive
PROFIS	Yes
Storage and transportation temperature - max.	25 °C
Base material condition	Dry, wet
Anchoring elements	HAS threaded rods

Ordering designation	Drill bit diameter	Standard embedment depth	Sales pack quantity	Item number
HVU M8X80	10 mm	80 mm	10	256691
HVU M10X90	12 mm	90 mm	10	256692
HVU M12X110	14 mm	110 mm	10	256693
HVU M16X125	18 mm	125 mm	10	256694
HVU M20X170	24 mm	170 mm	5	256695
HVU M24X210	28 mm	210 mm	5	256696
HVU M27X240	30 mm	240 mm	4	256697
HVU M30X270	35 mm	270 mm	4	256698
HVU M33X300	37 mm	300 mm	4	256699
HVU M36X330	40 mm	330 mm	2	256700
HVU M39X360	42 mm	360 mm	2	256701

Anchor rod HIT-Z

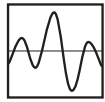

Technical data

Material composition	Steel, zinc-plated (min. 5 µm)
Material, corrosion	Steel, zinc-plated
Environmental conditions	Indoor, dry conditions
Tested/approved for diamond drilling	Yes
PROFIS	Yes
Seismic	Yes

Applications

- Anchor rod for use with HIT-HY 200-R

Base materials

- Concrete (cracked)
- Concrete (uncracked)

Ordering designation	Anchor size	Drill bit diameter	Anchor length	Max. fixture thickness at standard embedment depth	Required tightening torque	Sales pack quantity	Item number
HIT-Z M8x100	M8	10 mm	100 mm	28 mm	10 Nm	40	2018365
HIT-Z M10x95	M10	12 mm	95 mm	22 mm	25 Nm	40	2018367
HIT-Z M10x115	M10	12 mm	115 mm	42 mm	25 Nm	40	2018368
HIT-Z M12x105	M12	14 mm	105 mm	29 mm	40 Nm	20	2018411
HIT-Z M12x140	M12	14 mm	140 mm	64 mm	40 Nm	20	2018412
HIT-Z M16x155	M16	18 mm	155 mm	38 mm	80 Nm	12	2018416
HIT-Z M16x175	M16	18 mm	175 mm	58 mm	80 Nm	12	2018417
HIT-Z M20x215	M20	22 mm	215 mm	91 mm	150 Nm	6	2018420

Anchor rod HIT-Z-R

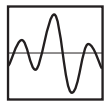

Technical data

Material composition	Steel, A4 (SS316)
Material, corrosion	Steel, stainless
Environmental conditions	Covered by ground soil, outdoor, underwater, fresh water
Tested/approved for diamond drilling	Yes
PROFIS	Yes
Seismic	Yes

Applications

- Anchor rod for use with HIT-HY 200-R

Base materials

- Concrete (cracked)
- Concrete (uncracked)

Ordering designation	Anchor size	Drill bit diameter	Anchor length	Max. fixture thickness at standard embedment depth	Required tightening torque	Sales pack quantity	Item number
HIT-Z-R M8x100	M8	10 mm	100 mm	28 mm	10 Nm	40	2018423
HIT-Z-R M10x95	M10	12 mm	95 mm	22 mm	25 Nm	40	2018425
HIT-Z-R M10x115	M10	12 mm	115 mm	42 mm	25 Nm	40	2018426
HIT-Z-R M12x105	M12	14 mm	105 mm	29 mm	40 Nm	20	2018429
HIT-Z-R M12x140	M12	14 mm	140 mm	64 mm	40 Nm	20	2018430
HIT-Z-R M16x155	M16	18 mm	155 mm	58 mm	80 Nm	12	2018434
HIT-Z-R M16x175	M16	18 mm	175 mm	88 mm	80 Nm	12	2018435
HIT-Z-R M20x215	M20	24 mm	215 mm	91 mm	150 Nm	6	2018438

Anchor rod HAS-TZ



Technical data

Material, corrosion	Steel, zinc-plated
Environmental conditions	Indoor, dry conditions
PROFIS	Yes

Applications

- Anchor rod for use with HVU-TZ

Base materials

- Concrete (cracked)
- Concrete (uncracked)

Ordering designation	Anchor size	Drill bit diameter	Anchor length	Drilling depth	Max. fixture thickness at standard embedment depth	Required tightening torque	Sales pack quantity	Item number
HAS-TZ M10X75/15	M10	12 mm	124 mm	90 mm	15 mm	20 Nm	10	310018
HAS-TZ M12X95/25	M12	14 mm	158 mm	110 mm	25 mm	40 Nm	10	308385
HAS-TZ M12X95/50	M12	14 mm	183 mm	110 mm	50 mm	40 Nm	10	308386
HAS-TZ M16X105/30	M16	18 mm	181 mm	125 mm	30 mm	80 Nm	5	308388
HAS-TZ M16X125/30	M16	18 mm	201 mm	145 mm	30 mm	80 Nm	5	332519
HAS-TZ M16X105/60	M16	18 mm	211 mm	125 mm	60 mm	80 Nm	5	308389
HAS-TZ M16X125/60	M16	18 mm	231 mm	145 mm	60 mm	80 Nm	5	332520
HAS-TZ M20X170/40	M20	24 mm	269 mm	195 mm	40 mm	150 Nm	4	335943

Anchor rod HAS-E

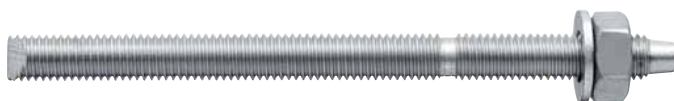

Technical data

Material composition	Steel, 5.8 grade, zinc-plated (min. 5 µm)
Material, corrosion	Steel, zinc-plated
Environmental conditions	Indoor, dry conditions
PROFIS	Yes

Applications

- Anchor rod for use with HVU and HIT systems

Base materials

- Concrete (cracked)
- Concrete (uncracked)
- Masonry (solid)

Ordering designation	Anchor size	Drill bit diameter	Anchor length	Drilling depth	Max. fixture thickness at standard embedment depth	Sales pack quantity	Item number
HAS-E M8X80/14	M8	10 mm	110 mm	80 mm	14 mm	20	332219
HAS-E M10X90/21	M10	12 mm	130 mm	90 mm	21 mm	20	332220
HAS-E M10X90/61	M10	12 mm	170 mm	90 mm	61 mm	10	333100
HAS-E M12X110/28	M12	14 mm	160 mm	110 mm	28 mm	20	332221
HAS-E M12X110/88	M12	14 mm	220 mm	110 mm	88 mm	10	333102
HAS-E M16X125/38	M16	18 mm	190 mm	125 mm	38 mm	20	332222
HAS-E M16X125/108	M16	18 mm	260 mm	125 mm	108 mm	10	333106
HAS-E M20X170/48	M20	22 mm	240 mm	170 mm	48 mm	10	332223
HAS-E M20X170/68	M20	22 mm	260 mm	170 mm	68 mm	10	333110
HAS-E M24X210/54	M24	28 mm	290 mm	210 mm	54 mm	10	332224

Anchor rod HAS-E 8.8

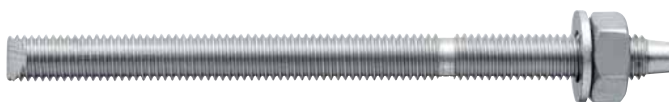

Technical data

Material composition	Steel, 8.8 grade, zinc-plated (min. 5 µm)
Material, corrosion	Steel, zinc-plated
Environmental conditions	Indoor, dry conditions
PROFIS	Yes

Base materials

- Concrete (cracked)
- Concrete (uncracked)

Applications

- Anchor rod for use with HVU and HIT systems

Ordering designation	Anchor size	Drill bit diameter	Anchor length	Drilling depth	Max. fixture thickness at standard embedment depth	Sales pack quantity	Item number
HAS-E M27X240/60	M27	30 mm	340 mm	240 mm	60 mm	4	333114
HAS-E M30X270/70	M30	35 mm	380 mm	270 mm	70 mm	4	333115
HAS-E M33X300/80	M33	37 mm	420 mm	300 mm	80 mm	4	333116
HAS-E M36X330/90	M36	40 mm	460 mm	330 mm	90 mm	2	333117
HAS-E M39X360/100	M39	42 mm	510 mm	360 mm	100 mm	2	333118

Anchor rod HAS-E-F



Technical data

Material composition	Steel, 5.8 grade, hot-dip galvanized (min. 43 µm)
Material, corrosion	Steel, sherardized / hot-dip galvanized
Environmental conditions	Indoor, damp conditions, outdoor
PROFIS	Yes

Base materials

- Concrete (cracked)
- Concrete (uncracked)
- Masonry (solid)

Applications

- Anchor rod for use with HVU and HIT systems

Ordering designation	Anchor size	Drill bit diameter	Anchor length	Drilling depth	Max. fixture thickness at standard embedment depth	Sales pack quantity	Item number
HAS-E-F M8X80/14	M8	10 mm	110 mm	80 mm	14 mm	20	333143
HAS-E-F M10X90/21	M10	12 mm	130 mm	90 mm	21 mm	20	333145
HAS-E-F M12X110/28	M12	14 mm	160 mm	110 mm	28 mm	20	333148
HAS-E-F M12X110/88	M12	14 mm	220 mm	110 mm	88 mm	10	333149
HAS-E-F M12X110/128	M12	14 mm	260 mm	110 mm	128 mm	10	333150
HAS-E-F M16X125/38	M16	18 mm	190 mm	125 mm	38 mm	20	333153
HAS-E-F M16X125/108	M16	18 mm	260 mm	125 mm	108 mm	10	333154
HAS-E-F M20X170/48	M20	24 mm	240 mm	170 mm	48 mm	10	333158
HAS-E-F M24X210/54	M24	28 mm	290 mm	210 mm	54 mm	10	333163

Anchor rod HAS-E-F 8.8



Technical data

Material composition	Steel, 8.8 grade, hot-dip galvanized (min. 43 µm)
Material, corrosion	Steel, sherardized / hot-dip galvanized
Environmental conditions	Indoor, dry conditions, outdoor
PROFIS	Yes

Applications

- Anchor rod for use with HVU and HIT systems

Base materials

- Concrete (cracked)
- Concrete (uncracked)

Ordering designation	Anchor size	Drill bit diameter	Anchor length	Drilling depth	Max. fixture thickness at standard embedment depth	Sales pack quantity	Item number
HAS-E-F M27X240/60	M27	30 mm	340 mm	240 mm	60 mm	4	333164
HAS-E-F M30X270/70	M30	35 mm	380 mm	270 mm	70 mm	4	333165
HAS-E-F M33X300/80	M33	37 mm	420 mm	300 mm	80 mm	4	333166
HAS-E-F M36X330/90	M36	40 mm	460 mm	330 mm	90 mm	2	333167
HAS-E-F M39X360/100	M39	42 mm	510 mm	360 mm	100 mm	2	333168

Anchor rod HAS-E-R

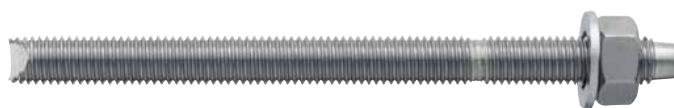

Technical data

Material composition	Steel, A4 (SS316)
Material, corrosion	Steel, stainless
Environmental conditions	Covered by ground soil, outdoor, underwater, fresh water
PROFIS	Yes

Applications

- Anchor rod for use with HVU and HIT systems

Base materials

- Concrete (cracked)
- Concrete (uncracked)
- Masonry (solid)

Ordering designation	Anchor size	Drill bit diameter	Anchor length	Drilling depth	Max. fixture thickness at standard embedment depth	Sales pack quantity	Item number
HAS-E-R M8X80/14	M8	10 mm	110 mm	80 mm	14 mm	20	333119
HAS-E-R M10X90/21	M10	12 mm	130 mm	90 mm	21 mm	20	333122
HAS-E-R M12X110/28	M12	14 mm	160 mm	110 mm	28 mm	20	333126
HAS-E-R M12X110/88	M12	14 mm	220 mm	110 mm	88 mm	10	333127
HAS-E-R M16X125/38	M16	18 mm	190 mm	125 mm	38 mm	20	333131
HAS-E-R M16X125/108	M16	18 mm	260 mm	125 mm	108 mm	10	333132
HAS-E-R M20X170/48	M20	24 mm	240 mm	170 mm	48 mm	10	333135
HAS-E-R M20X170/108	M20	24 mm	300 mm	170 mm	108 mm	10	333136
HAS-E-R M24X210/54	M24	28 mm	290 mm	210 mm	54 mm	10	333137
HAS-E-R M27X240/60	M27	30 mm	340 mm	240 mm	60 mm	4	333138
HAS-E-R M30X270/70	M30	35 mm	380 mm	270 mm	70 mm	4	333139
HAS-E-R M33X300/80	M33	37 mm	420 mm	300 mm	80 mm	4	333140
HAS-E-R M36X330/90	M36	40 mm	460 mm	330 mm	90 mm	2	333141
HAS-E-R M39X360/100	M39	42 mm	510 mm	360 mm	100 mm	2	333142

Dispenser HDE 500-A22



Applications

- Injection of Hilti HIT adhesive mortar for fastening anchor rods and rebars in concrete and masonry
- No need for external power source supply
- Serial fastenings and/or injection in deep holes

Advantages

- Dose adjustment knob for accurate and controlled dispensing
- Fast, easy foil pack loading
- High battery capacity (up to 100x500ml foil packs)



reddot design award
winner 2013



Technical data

Dispenser, setting tool, accessory, tester type	Dispensers
--	------------

Ordering designation	Weight	Sales pack quantity	Item number
HDE 500-A22 CR/CB cas	2.2 kg	1	2005637
Battery pack B 22/3.3 Li-ion		1	2007431
Battery charger C 4/36-350 230V		1	2008876

Dispenser HDM



Applications

- Injection of Hilti HIT adhesive mortar for fastening anchor rods and rebars in concrete and masonry

Advantages





- Fast, easy foil pack loading

Technical data

Dispenser, setting tool, accessory, tester type	Dispensers
--	------------

Ordering designation	Package contents	Weight	Sales pack quantity	Item number
HDM 330 cas	1x Body, 1x Red cartridge holder, 1x Black cartridge holder, 1x Safety goggles		1	2036319
HDM 500 cas	1x Body, 1x Red cartridge holder, 1x Black cartridge holder, 1x Safety goggles		1	2036320
HDM 330 box	1x Body	1.5 kg	1	2005640
HDM 500 box	1x Body	1.8 kg	1	2005641

Accessories for Injectible Adhesive Anchors

Ordering designation		HIT-RE 500	HIT-HY 200-R	HIT-HY 70	HIT-MM PLUS	Sales pack quantity	Item number
Cartridge holder HIT-CB 330		■		■	■	1	2007056
Cartridge holder HIT-CB 500		■		■	■	1	2007057
Cartridge holder HIT-CR 330			■			1	2007058
Cartridge holder HIT-CR 500			■			1	2007059

Accessories for blowing out drilled holes Hilti HIT



Applications

- For fast and efficient removal of dust and debris from drilled holes of varying diameters and depths to allow correct installation of anchors and rebar

Technical data

Dispenser, setting tool, accessory, tester type	Cleaning accessories
---	----------------------

Ordering designation	Sales pack quantity	Item number
Blow-out pump	1	60579

Mixers and extensions Hilti HIT



Technical data

Dispenser, setting tool, accessory, tester type	Mixing nozzles and injection accessories
---	--

Ordering designation	Sales pack quantity	Item number
Mixer HIT-RE-M	1	337111

Setting tool TE-C HEX / TE-Y HEX



Applications

- Setting tool for installing HAS-TZ with HVU-TZ

Technical data

Dispenser, setting tool, accessory, tester type	Setting tools
---	---------------

Ordering designation	Sales pack quantity	Item number
TE-C HEX M10	1	311415
TE-C HEX M12	1	311416
TE-C HEX M16	1	311417
TE-Y HEX M20	1	336420

Setting tool TE-C-E



Applications

- Setting tool for installing HAS-E with HVU

Technical data

Dispenser, setting tool, accessory, tester type	Setting tools
---	---------------

Ordering designation	Connection end	Sales pack quantity	Item number
TE-C-E M8	TE-C	1	369223
TE-C-E M10	TE-C	1	369224
TE-C-E M12	TE-C	1	369225
TE-C-E M16	TE-C	1	369226

Setting tool TE-Y-E



Applications

- Setting tool for installing HAS-E with HVU

Technical data

Dispenser, setting tool, accessory, tester type	Setting tools
--	---------------

Ordering designation	Connection end	Sales pack quantity	Item number
TE-Y-E M16	TE-Y	1	369227
TE-Y-E M20	TE-Y	1	369228
TE-Y-E M24	TE-Y	1	369229

Undercut anchor HDA-T



Base materials

- Concrete (cracked)
- Concrete (uncracked)

Applications

- Safety-relevant, heavy-duty fastenings for all dynamic loading (shock, seismic and fatigue) in cracked or uncracked concrete, including applications in nuclear power plants
- Fastenings to support heavy pipes, safety barriers, industrial machines, crane rails, dorm structures, crash barriers, roof fixings, elevator tracks, bridge retrofitting etc.

Advantages

- Self-undercutting facilitates fast and reliable installation without the need for separate undercutting tool or handling
- Combines the advantages of a post-installed mechanical anchor, i.e. flexibility and immediate loading, with the performance of a cast-in-place headed stud
- Close spacing and small edge distance because of low expansion forces

Technical data

Material composition	Bolt: steel, 8.8 grade, zinc-plated (min. 5 µm)
Head configuration	Externally threaded
Type of fastening	Through - fastening
PROFIS	Yes
Additional product information	Manufactured under a nuclear quality assurance program according to ASME NQA-1 and 10CFR50 App. B

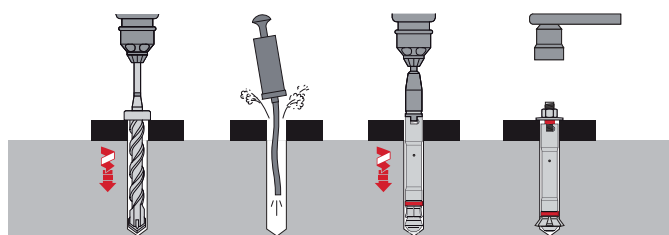

Ordering designation	Anchor size	Max. fixture thickness at standard embedment depth	Base plate clearance hole	Drilling depth	Required tightening torque	Wrench size	Sales pack quantity	Item number
HDA-T M10x100/20	M10	20 mm	21 mm	127 mm	50 Nm	17 mm	12	331545
HDA-T M12x125/30	M12	30 mm	23 mm	163 mm	80 Nm	19 mm	8	331548
HDA-T M12x125/50	M12	50 mm	23 mm	183 mm	80 Nm	19 mm	8	331549
HDA-T M16x190/40	M16	40 mm	32 mm	243 mm	120 Nm	24 mm	4	331552
HDA-T M16x190/60	M16	60 mm	32 mm	263 mm	120 Nm	24 mm	4	331553
HDA-T M20x250/50	M20	50 mm	40 mm	316 mm	300 Nm	30 mm	2	339267
HDA-T M20x250/100	M20	100 mm	40 mm	366 mm	300 Nm	30 mm	2	339268

Undercut anchor HDA-TF



Base materials

- Concrete (cracked)
- Concrete (uncracked)

Applications

- Safety-relevant heavy-duty fastenings for all dynamic loading in cracked or uncracked concrete, including applications in nuclear power plants
- Examples of applications: supports for heavy pipes, safety barriers, industrial machines, crane rails, dorm structures, crash barriers, roof fixings, elevator tracks, bridge retrofitting etc.

Advantages

- Combines the advantages of a post-installed mechanical anchor, i.e. flexibility and immediate loading, with the performance of a cast-in-place headed stud
- Close spacing and small edge distance because of very low expansion forces
- Self-undercutting facilitates fast and reliable installation. No separate undercutting tool or handling needed

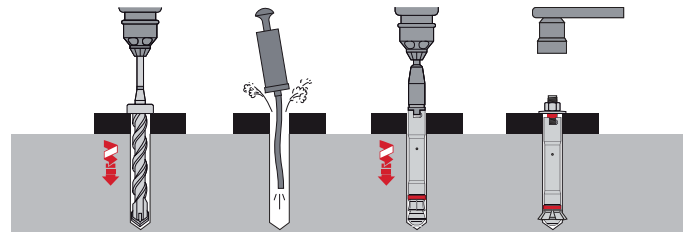

Technical data

Material composition	Bolt: steel, 8.8 grade, sherardized (min. 53 µm)
Head configuration	Externally threaded
Type of fastening	Through - fastening
PROFIS	Yes
Additional product information	Manufactured under a nuclear quality assurance program according to ASME NQA-1-2000 and 10CFR50 App. B

Ordering designation	Anchor size	Max. fixture thickness at standard embedment depth	Base plate clearance hole	Drilling depth	Required tightening torque	Wrench size	Sales pack quantity	Item number
HDA-TF M10x100/20	M10	20 mm	21 mm	127 mm	50 Nm	17 mm	12	412903
HDA-TF M12x125/30	M12	30 mm	23 mm	163 mm	80 Nm	19 mm	8	412904
HDA-TF M12x125/50	M12	50 mm	23 mm	183 mm	80 Nm	19 mm	8	412905
HDA-TF M16x190/40	M16	40 mm	32 mm	243 mm	120 Nm	24 mm	4	339364
HDA-TF M16x190/60	M16	60 mm	32 mm	263 mm	120 Nm	24 mm	4	339365

Undercut anchor HDA-TR



Base materials

- Concrete (cracked)
- Concrete (uncracked)

Applications

- Safety-relevant, heavy-duty fastening for dynamic loading in cracked or uncracked concrete and corrosive environments, including applications in nuclear power plants
- Anchoring supports for heavy pipes, safety barriers, industrial machines, crane rails, dorm structures, crash barriers, roof fixings, elevator tracks, bridge retrofitting etc.

Advantages

- Combines the advantages of a post-installed mechanical anchor, i.e. flexibility and immediate loading, with the performance of a cast-in-place headed stud
- Close spacing and small edge distance because of low expansion forces
- Self-undercutting facilitates fast and reliable installation without the need for additional tools

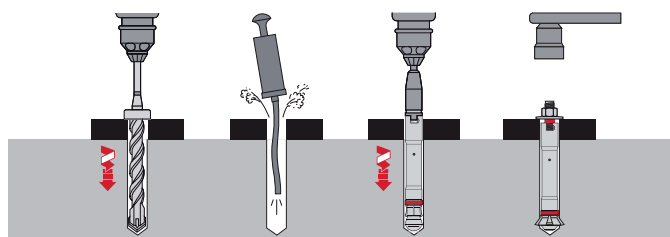
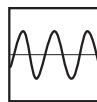

Technical data

Material composition	Steel, A4 (SS316)
Head configuration	Externally threaded
Type of fastening	Through - fastening
PROFIS	Yes
Additional product information	Manufactured under a nuclear quality assurance program according to ASME NQA-1 and 10CFR50 App. B

Ordering designation	Anchor size	Max. fixture thickness at standard embedment depth	Base plate clearance hole	Drilling depth	Required tightening torque	Wrench size	Sales pack quantity	Item number
HDA-TR M10x100/20	M10	20 mm	21 mm	127 mm	50 Nm	17 mm	12	339351
HDA-TR M12x125/30	M12	30 mm	23 mm	163 mm	80 Nm	19 mm	8	339352
HDA-TR M12x125/50	M12	50 mm	23 mm	163 mm	80 Nm	19 mm	8	339353
HDA-TR M16x190/40	M16	40 mm	32 mm	263 mm	120 Nm	24 mm	4	339354
HDA-TR M16x190/60	M16	60 mm	32 mm	263 mm	120 Nm	24 mm	4	339355

Undercut anchor HDA-P



Base materials

- Concrete (cracked)
- Concrete (uncracked)

Applications

- Safety-relevant, heavy-duty fastenings for all dynamic loading (shock, seismic and fatigue) in cracked or uncracked concrete, including applications in nuclear power plants
- Fastenings to support heavy pipes, safety barriers, industrial machines, crane rails, dorm structures, crash barriers, roof fixings, elevator tracks, bridge retrofitting etc.

Advantages

- Self-undercutting facilitates fast and reliable installation without the need for separate undercutting tool or handling
- Combines the flexibility and immediate loading of a post-installed mechanical anchor with the performance of a cast-in-place headed stud
- Close spacing and small edge distance because of low expansion forces

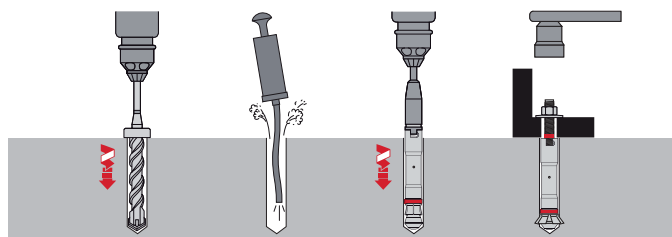
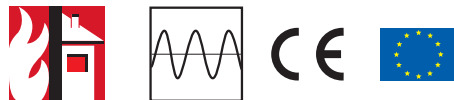

Technical data

Material composition	Bolt: steel, 8.8 grade, zinc-plated (min. 5 µm)
Head configuration	Externally threaded
Type of fastening	Pre - fastening
PROFIS	Yes
Additional product information	Manufactured under a nuclear quality assurance program according to ASME NQA-1 and 10CFR50 App. B

Ordering designation	Anchor size	Max. fixture thickness at standard embedment depth	Base plate clearance hole	Drilling depth	Required tightening torque	Wrench size	Sales pack quantity	Item number
HDA-P M10x100/20	M10	20 mm	12 mm	107 mm	50 Nm	17 mm	12	331544
HDA-P M12x125/30	M12	30 mm	14 mm	133 mm	80 Nm	19 mm	8	331546
HDA-P M12x125/50	M12	50 mm	14 mm	133 mm	80 Nm	19 mm	8	331547
HDA-P M16x190/40	M16	40 mm	18 mm	203 mm	120 Nm	24 mm	4	331550
HDA-P M16x190/60	M16	60 mm	18 mm	203 mm	120 Nm	24 mm	4	331551
HDA-P M20x250/50	M20	50 mm	22 mm	266 mm	300 Nm	30 mm	2	339265
HDA-P M20x250/100	M20	100 mm	22 mm	266 mm	300 Nm	30 mm	2	339266

Undercut anchor HDA-PF



Base materials

- Concrete (cracked)
- Concrete (uncracked)

Applications

- Safety-relevant heavy-duty fastenings for all dynamic loading in cracked or uncracked concrete, including applications in nuclear power plants
- Examples of applications: supports for heavy pipes, safety barriers, industrial machines, crane rails, dorm structures, crash barriers, roof fixings, elevator tracks, bridge retrofitting etc.

Advantages

- Combines the advantages of a post-installed mechanical anchor, i.e. flexibility and immediate loading, with the performance of a cast-in-place headed stud
- Close spacing and small edge distance because of very low expansion forces
- Self-undercutting facilitates fast and reliable installation. No separate undercutting tool or handling needed

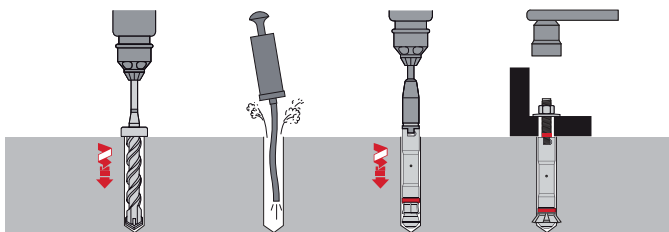

Technical data

Material composition	Bolt: steel, 8.8 grade, sherardized (min. 53 µm)
Head configuration	Externally threaded
Type of fastening	Pre - fastening
PROFIS	Yes
Additional product information	Manufactured under a nuclear quality assurance program according to ASME NQA-1-2000 and 10CFR50 App. B

Ordering designation	Anchor size	Max. fixture thickness at standard embedment depth	Base plate clearance hole	Drilling depth	Required tightening torque	Wrench size	Sales pack quantity	Item number
HDA-PF M10x100/20	M10	20 mm	12 mm	107 mm	50 Nm	17 mm	12	339356
HDA-PF M12x125/30	M12	30 mm	14 mm	133 mm	80 Nm	19 mm	8	339357
HDA-PF M12x125/50	M12	50 mm	14 mm	133 mm	80 Nm	19 mm	8	339358
HDA-PF M16x190/40	M16	40 mm	18 mm	203 mm	120 Nm	24 mm	4	339359
HDA-PF M16x190/60	M16	60 mm	18 mm	203 mm	120 Nm	24 mm	4	339360

Undercut anchor HDA-PR



Base materials

- Concrete (cracked)
- Concrete (uncracked)

Applications

- Safety-relevant, heavy-duty fastening for dynamic loading in cracked or uncracked concrete and corrosive environments, including applications in nuclear power plants
- Anchoring supports for heavy pipes, safety barriers, industrial machines, crane rails, dorm structures, crash barriers, roof fixings, elevator tracks, bridge retrofitting etc.

Advantages

- Combines the flexibility and immediate loading of a post-installed mechanical anchor with the performance of a cast-in-place headed stud
- Close spacing and small edge distance because of low expansion forces
- Self-undercutting facilitates fast and reliable installation without the need for additional tools

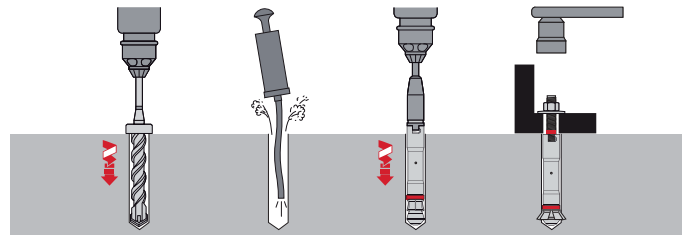
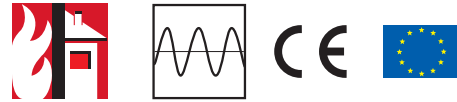

Technical data

Material composition	Steel, A4 (SS316)
Head configuration	Externally threaded
Type of fastening	Pre - fastening
PROFIS	Yes
Additional product information	Manufactured under a nuclear quality assurance program according to ASME NQA-1-2000 and 10CFR50 App. B

Ordering designation	Anchor size	Max. fixture thickness at standard embedment depth	Base plate clearance hole	Drilling depth	Required tightening torque	Wrench size	Sales pack quantity	Item number
HDA-PR M10x100/20	M10	20 mm	12 mm	107 mm	50 Nm	17 mm	12	339346
HDA-PR M12x125/30	M12	30 mm	14 mm	133 mm	80 Nm	19 mm	8	339347
HDA-PR M12x125/50	M12	50 mm	14 mm	133 mm	80 Nm	19 mm	8	339348
HDA-PR M16x190/40	M16	40 mm	18 mm	203 mm	120 Nm	24 mm	4	339349
HDA-PR M16x190/60	M16	60 mm	18 mm	203 mm	120 Nm	24 mm	4	339350

Safety anchor HSC-A



Base materials

- Concrete (cracked)
- Concrete (uncracked)

Applications

- Safety relevant medium-duty fastenings in cracked or non-cracked concrete, especially where shallow embedment and/or small edge distance or close spacing is required
- Examples are stair hand rails, sprinkler pipes, air ducts, seating, facade substructures, car park barriers, etc.

Advantages

- Shallow embedment depth for thin concrete slabs or where permissible drilling depth is limited
- Combines the advantages of high working loads with small edge distances and close spacing thanks to very low expansion forces
- Self-undercutting facilitates fast and reliable installation. No separate undercutting tool or handling needed

Technical data

Material composition	Bolt: steel, 8.8 grade, zinc-plated (min. 5 µm)
Head configuration	Externally threaded
PROFIS	Yes

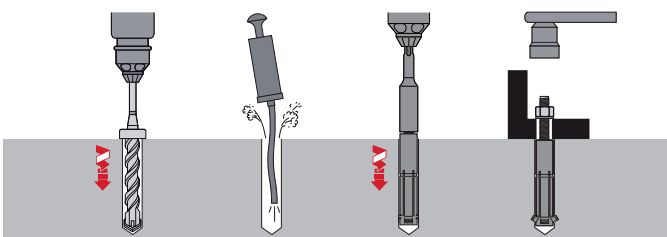

Ordering designation	Anchor size	Max. fixture thickness at standard embedment depth	Base plate clearance hole	Drilling depth	Required tightening torque	Wrench size	Sales pack quantity	Item number
HSC-A M8x40/15	M8	15 mm	9 mm	46 mm	10 Nm	13 mm	25	31139
HSC-A M8x50/15	M8	15 mm	9 mm	56 mm	10 Nm	13 mm	25	31141
HSC-A M10x40/20	M10	20 mm	12 mm	47 mm	20 Nm	17 mm	25	31140
HSC-A M12x60/20	M12	20 mm	14 mm	68 mm	30 Nm	19 mm	20	15507

Safety anchor HSC-AR



Base materials

- Concrete (cracked)
- Concrete (uncracked)

Applications

- Safety-relevant medium-duty fastenings in cracked or uncracked concrete and in corrosive environments, especially where shallow embedment and/or small edge distances or close spacing are required
- For various applications such as stair hand rails, balcony safety railings, sprinkler pipes, air ducts, seating, facade substructures, car park barriers, etc.

Advantages

- Shallow embedment depth for thin concrete slabs or where permissible drilling depth is limited
- Combines the advantages of high working loads with small edge distances and close spacing thanks to very low expansion forces
- Self-undercutting facilitates fast and reliable installation. No separate undercutting tool or handling needed

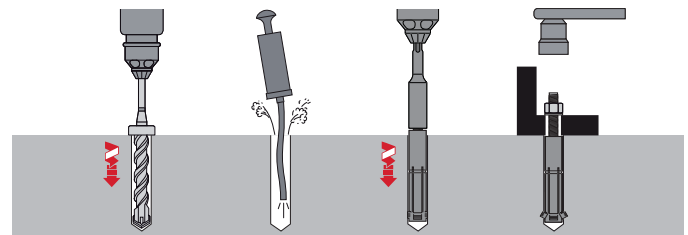

Technical data

Material composition	Steel, A4 (SS316)
Head configuration	Externally threaded
PROFIS	Yes

Ordering designation	Anchor size	Max. fixture thickness at standard embedment depth	Base plate clearance hole	Drilling depth	Required tightening torque	Wrench size	Sales pack quantity	Item number
HSC-AR M8x40/15	M8	15 mm	9 mm	46 mm	10 Nm	13 mm	25	31148
HSC-AR M8x50/15	M8	15 mm	9 mm	56 mm	10 Nm	13 mm	25	31150
HSC-AR M10x40/20	M10	20 mm	12 mm	47 mm	20 Nm	17 mm	25	31149
HSC-AR M12x60/20	M12	20 mm	14 mm	68 mm	30 Nm	19 mm	20	15506

Safety anchor HSC-I



Base materials

- Concrete (cracked)
- Concrete (uncracked)

Applications

- Safety relevant medium-duty fastenings in cracked or non-cracked concrete, especially where shallow embedment and/or small edge distance or close spacing is required
- Examples are stair hand rails, sprinkler pipes, air ducts, seating, facade substructures, car park barriers, etc.

Advantages

- Shallow embedment depth for thin concrete slabs or where permissible drilling depth is limited
- Combines the advantages of high working loads with small edge distances and close spacing thanks to very low expansion forces
- Self-undercutting facilitates fast and reliable installation. No separate undercutting tool or handling needed

Technical data

Material composition	Bolt: steel, 8.8 grade, zinc-plated (min. 5 µm)
Head configuration	Inner thread
PROFIS	Yes

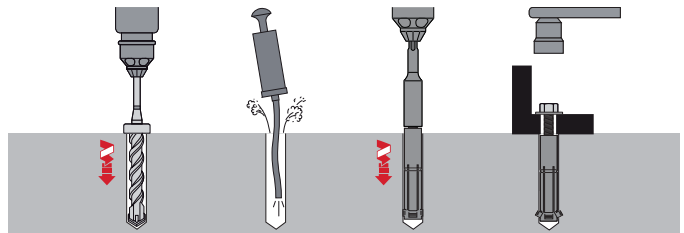

Ordering designation	Anchor size	Internal thread size	Base plate clearance hole	Drilling depth	Required tightening torque	Sales pack quantity	Item number
HSC-I M6x40	M6	6 mm	7 mm	46 mm	10 Nm	25	31142
HSC-I M8x40	M8	8 mm	9 mm	47 mm	10 Nm	25	31143
HSC-I M10x50	M10	10 mm	12 mm	56 mm	20 Nm	25	31144
HSC-I M10x60	M10	10 mm	12 mm	68 mm	20 Nm	25	31145
HSC-I M12x60	M12	12 mm	14 mm	69 mm	30 Nm	25	31146

Safety anchor HSC-IR



Base materials

- Concrete (cracked)
- Concrete (uncracked)

Applications

- Safety-relevant medium-duty fastenings in cracked or uncracked concrete and in corrosive environments, especially where shallow embedment and/or small edge distances or close spacing are required
- For various applications such as stair hand rails, balcony safety railings, sprinkler pipes, air ducts, seating, facade substructures, car park barriers, etc.

Advantages

- Shallow embedment depth for thin concrete slabs or where permissible drilling depth is limited
- Combines the advantages of high working loads with small edge distances and close spacing thanks to very low expansion forces
- Self-undercutting facilitates fast and reliable installation. No separate undercutting tool or handling needed

Technical data

Material composition	Steel, A4 (SS316)
Head configuration	Inner thread
PROFIS	Yes

Ordering designation	Anchor size	Internal thread size	Base plate clearance hole	Drilling depth	Required tightening torque	Sales pack quantity	Item number
HSC-IR M6x40	M6	6 mm	7 mm	46 mm	10 Nm	25	31151
HSC-IR M8x40	M8	8 mm	9 mm	47 mm	10 Nm	25	31152
HSC-IR M10x50	M10	10 mm	12 mm	56 mm	20 Nm	25	31153
HSC-IR M10x60	M10	10 mm	12 mm	68 mm	20 Nm	25	31154
HSC-IR M12x60	M12	12 mm	14 mm	69 mm	30 Nm	25	31155

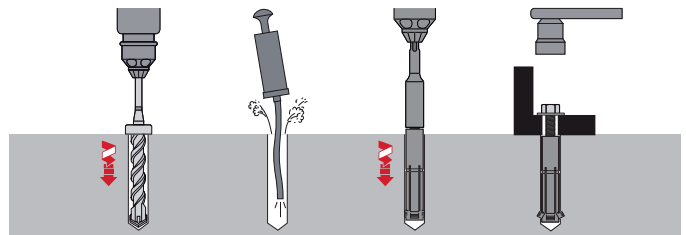

Heavy-duty anchor HSL-3



Base materials

- Concrete (cracked)
- Concrete (uncracked)

Applications

- Heavy-duty fastenings in high safety-relevant or dynamic applications, including applications in nuclear power plants
- Heavy-duty applications e.g machines, heavy equipment, steel columns, heavy pipe supports, pumps, beam supports, medical equipment, cantilevers, cranes, car hoists, etc.

Advantages

- High tension and shear load capacities
- Force-controlled expansion which allows follow-up expansion
- ETA Option 1 for cracked and uncracked concrete

Technical data

Material composition	Steel, zinc-plated (min. 5 µm), Bolt: steel, 8.8 grade, zinc-plated (min. 5 µm)
Head configuration	Hex head
PROFIS	Yes

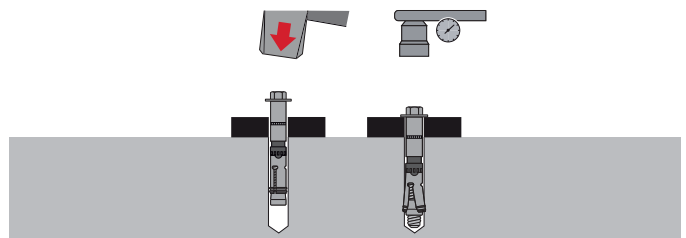

Ordering designation	Anchor size	Anchor length	Drill bit diameter	Base plate clearance hole	Required tightening torque	Wrench size	Sales pack quantity	Item number
HSL-3 M8/20	M8	98 mm	12 mm	14 mm	25 Nm	13 mm	40	371775
HSL-3 M10/20	M10	110 mm	15 mm	17 mm	50 Nm	17 mm	20	371778
HSL-3 M12/25	M12	131 mm	18 mm	20 mm	80 Nm	19 mm	20	371781
HSL-3 M12/50	M12	156 mm	18 mm	20 mm	80 Nm	19 mm	10	371782
HSL-3 M16/25	M16	153 mm	24 mm	26 mm	120 Nm	24 mm	10	371784
HSL-3 M16/50	M16	178 mm	24 mm	26 mm	120 Nm	24 mm	10	371785
HSL-3 M20/30	M20	183 mm	28 mm	31 mm	200 Nm	30 mm	6	371787
HSL-3 M20/60	M20	213 mm	28 mm	31 mm	200 Nm	30 mm	6	371788
HSL-3 M24/30	M24	205 mm	32 mm	35 mm	250 Nm	36 mm	4	371790

Heavy-duty anchor HSL-3-B



Base materials

- Concrete (cracked)
- Concrete (uncracked)

Applications

- Heavy-duty fastenings in highly safety-relevant or dynamic applications, including applications in nuclear power plants
- Applications where extensive approval back-up or technical back-up is required, e.g. machines, heavy equipment, steel columns, heavy pipe supports, pumps, beam supports, medical equipment, cantilevers, cranes, car hoists, etc.

Advantages

- Special safety cap ensures that the correct installation torque is always applied even without using a torque wrench
- High tension and shear load capacity
- Force-controlled expansion which allows follow-up expansion

Technical data

Material composition	Steel, zinc-plated (min. 5 µm), Bolt: steel, 8.8 grade, zinc-plated (min. 5 µm)
Head configuration	Safety cap (torque cap)
PROFIS	Yes

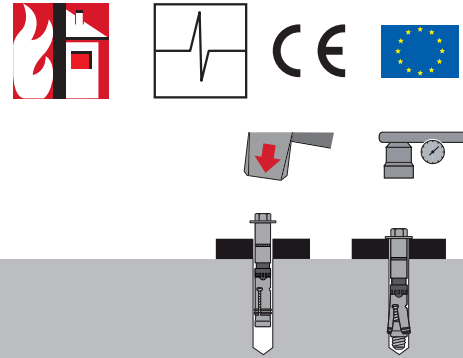

Ordering designation	Anchor size	Anchor length	Drill bit diameter	Base plate clearance hole	Required tightening torque	Wrench size	Sales pack quantity	Item number
HSL-3-B M12/25	M12	137 mm	18 mm	20 mm	80 Nm	24 mm	20	371808
HSL-3-B M16/25	M16	159 mm	24 mm	26 mm	120 Nm	30 mm	10	371811
HSL-3-B M20/30	M20	189 mm	28 mm	31 mm	200 Nm	36 mm	6	371814
HSL-3-B M24/30	M24	211 mm	32 mm	35 mm	250 Nm	41 mm	4	371817

Heavy-duty anchor HSL-3-G



Base materials

- Concrete (cracked)
- Concrete (uncracked)

Applications

- Heavy-duty fastenings in high safety-relevant or dynamic applications, including applications in nuclear power plants
- Applications where extensive approval back-up or technical back-up is required, e.g. machines, heavy equipment, steel columns, heavy pipe supports, pumps, beam supports, medical equipment, cantilevers, cranes, car hoists, etc.

Advantages

- High tension and shear load capacity
- Force-controlled expansion which allows follow-up expansion
- ETA Option 1 for cracked and uncracked concrete

Technical data

Material composition	Steel, zinc-plated (min. 5 µm), Bolt: steel, 8.8 grade, zinc-plated (min. 5 µm)
Head configuration	Externally threaded
PROFIS	Yes

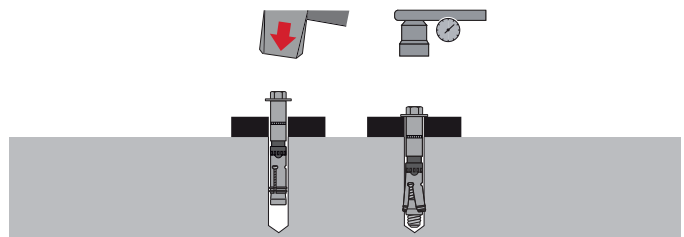

Ordering designation	Anchor size	Anchor length	Drill bit diameter	Base plate clearance hole	Required tightening torque	Wrench size	Sales pack quantity	Item number
HSL-3-G M8/20	M8	102 mm	12 mm	14 mm	20 Nm	13 mm	40	371793
HSL-3-G M10/20	M10	115 mm	15 mm	17 mm	35 Nm	17 mm	20	371796
HSL-3-G M12/25	M12	139 mm	18 mm	20 mm	60 Nm	19 mm	20	371799
HSL-3-G M16/25	M16	163 mm	24 mm	26 mm	80 Nm	24 mm	10	371802
HSL-3-G M20/30	M20	190 mm	28 mm	31 mm	160 Nm	30 mm	6	371805

Safety stud anchor HST



Base materials

- Concrete (cracked)
- Concrete (uncracked)

Applications

- Particularly suitable for safety relevant applications

Advantages

- High-performance stud anchor. The optimised design of the expansion pieces and tapered section combined with special steel and coatings ensure outstanding performance in cracked and uncracked concrete
- Suitable for applications in cracked concrete
- Product and length identification mark facilitates quality control and inspection

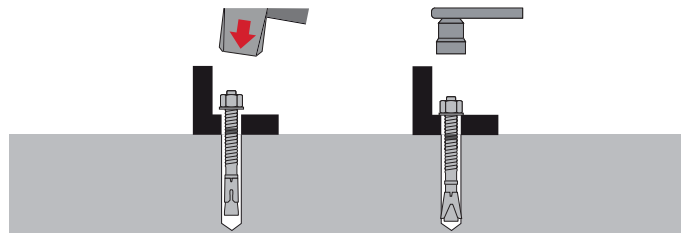

Safety stud anchor HST

Technical data

Material composition	Steel, zinc-plated (min. 5 µm)
Head configuration	Externally threaded
PROFIS	Yes



Ordering designation	Drill bit diameter	Anchor size	Anchor length	Base plate clearance hole	Required tightening torque	Socket size	Wrench size	Sales pack quantity	Item number
HST M8X75/10	8 mm	M8	75 mm	9 mm	20 Nm	13 mm	13 mm	100	371581
HST M10X90/10	10 mm	M10	90 mm	12 mm	45 Nm	17 mm	17 mm	50	371584
HST M12X115/20	12 mm	M12	115 mm	14 mm	60 Nm	19 mm	19 mm	25	371587
HST M12X145/50	12 mm	M12	145 mm	14 mm	60 Nm	19 mm	19 mm	25	371588
HST M16X140/25	16 mm	M16	140 mm	18 mm	110 Nm	24 mm	24 mm	12	371593
HST M16X165/50	16 mm	M16	165 mm	18 mm	110 Nm	24 mm	24 mm	12	371594
HST M20X170/30	20 mm	M20	170 mm	22 mm	240 Nm	30 mm	30 mm	5	371598
HST M20X200/60	20 mm	M20	200 mm	22 mm	240 Nm	30 mm	30 mm	5	371599
HST M24X200/30	24 mm	M24	200 mm	26 mm	300 Nm	36 mm	36 mm	5	371601

Safety stud anchor HST-R

Technical data

Material composition	Steel, A4 (SS316)
Head configuration	Externally threaded
PROFIS	Yes



Base materials

- Concrete (cracked)
- Concrete (uncracked)



Ordering designation	Drill bit diameter	Anchor size	Anchor length	Base plate clearance hole	Required tightening torque	Socket size	Wrench size	Sales pack quantity	Item number
HST-R M8x75/10	8 mm	M8	75 mm	9 mm	20 Nm	13 mm	13 mm	50	435447
HST-R M10x90/10	10 mm	M10	90 mm	12 mm	45 Nm	17 mm	17 mm	50	435450
HST-R M12x115/20	12 mm	M12	115 mm	14 mm	60 Nm	19 mm	19 mm	25	435454
HST-R M16X140/25	16 mm	M16	140 mm	18 mm	110 Nm	24 mm	24 mm	12	376051
HST-R M20X170/30	20 mm	M20	170 mm	22 mm	230 Nm	30 mm	30 mm	5	376056
HST-R M24X200/30	24 mm	M24	200 mm	26 mm	300 Nm	36 mm	36 mm	5	376058

Standard stud anchor HSA



Base materials

- Concrete (uncracked)

Applications

- Wide range of fastening applications in concrete
- Fastening columns and beams

Advantages

- ETA approved torquing with SIW 22-A impact wrench and S-TB
- Fast and easy anchor setting with S-TB
- Excellent edge and spacing distances
- High loads (optimal utilization of the concrete strength)
- 3 embedment depths offering maximum flexibility

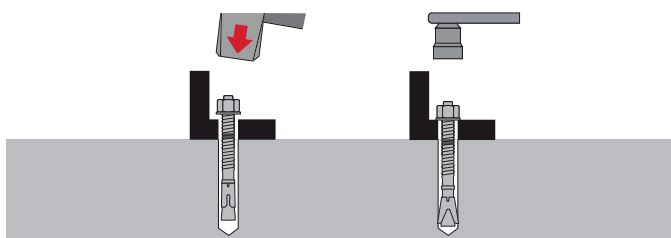

Standard stud anchor HSA

Technical data

Material composition	Steel, zinc-plated (min. 5 µm)
Head configuration	Externally threaded
PROFIS	Yes



Ordering designation	Drill bit diameter	Anchor size	Anchor length	Base plate clearance hole	Required tightening torque	Socket size	Wrench size	Sales pack quantity	Item number
HSA M6 5/-/-	6 mm	M6	50 mm	7 mm	5 Nm	10 mm	10 mm	200	2036084
HSA M6 20/10/-	6 mm	M6	65 mm	7 mm	5 Nm	10 mm	10 mm	200	2036085
HSA M8 5/-/-	8 mm	M8	55 mm	9 mm	15 Nm	13 mm	13 mm	100	2004122
HSA M8 20/10/-	8 mm	M8	70 mm	9 mm	15 Nm	13 mm	13 mm	100	2004123
HSA M8 35/25/-	8 mm	M8	85 mm	9 mm	15 Nm	13 mm	13 mm	80	2004124
HSA M10 5/-/-	10 mm	M10	68 mm	12 mm	25 Nm	17 mm	17 mm	50	2004127
HSA M10 20/10/-	10 mm	M10	83 mm	12 mm	25 Nm	17 mm	17 mm	50	2004128
HSA M10 35/25/-	10 mm	M10	98 mm	12 mm	25 Nm	17 mm	17 mm	40	2004129
HSA M10 50/40/10	10 mm	M10	113 mm	12 mm	25 Nm	17 mm	17 mm	40	2004150
HSA M12 5/-/-	12 mm	M12	85 mm	14 mm	50 Nm	19 mm	19 mm	25	2004154
HSA M12 20/5/-	12 mm	M12	100 mm	14 mm	50 Nm	19 mm	19 mm	25	2004155
HSA M12 35/20/-	12 mm	M12	115 mm	14 mm	50 Nm	19 mm	19 mm	25	2004156
HSA M12 65/50/15	12 mm	M12	145 mm	14 mm	50 Nm	19 mm	19 mm	25	2004157
HSA M12 95/80/45	12 mm	M12	175 mm	14 mm	50 Nm	19 mm	19 mm	25	2004158
HSA M16 5/-/-	16 mm	M16	102 mm	18 mm	80 Nm	24 mm	24 mm	16	2004161
HSA M16 20/5/-	16 mm	M16	117 mm	18 mm	80 Nm	24 mm	24 mm	16	2004162
HSA M16 40/25/-	16 mm	M16	137 mm	18 mm	80 Nm	24 mm	24 mm	16	2004163
HSA M16 85/70/30	16 mm	M16	182 mm	18 mm	80 Nm	24 mm	24 mm	16	2004164
HSA M16 135/120/80	16 mm	M16	232 mm	18 mm	80 Nm	24 mm	24 mm	16	2004165
HSA M20 10/-/-	20 mm	M20	125 mm	22 mm	200 Nm	30 mm	30 mm	10	2036088
HSA M20 55/30/15	20 mm	M20	170 mm	22 mm	200 Nm	30 mm	30 mm	10	2036089

Standard stud anchor HSA-F

Technical data

Material composition	Steel, hot-dip galvanized (min. 45 µm)
Head configuration	Externally threaded



Base materials

- Concrete (uncracked)

Ordering designation	Drill bit diameter	Anchor size	Anchor length	Base plate clearance hole	Required tightening torque	Socket size	Wrench size	Sales pack quantity	Item number
HSA-F M6 20/10/-	6 mm	M6	65 mm	7 mm	5 Nm	10 mm	10 mm	200	2036311
HSA-F M8 20/10/-	8 mm	M8	70 mm	9 mm	15 Nm	13 mm	13 mm	100	2004114
HSA-F M10 20/10/-	10 mm	M10	83 mm	12 mm	25 Nm	17 mm	17 mm	50	2004119
HSA-F M10 35/25/-	10 mm	M10	98 mm	12 mm	25 Nm	17 mm	17 mm	40	2004170
HSA-F M10 50/40/10	10 mm	M10	113 mm	12 mm	25 Nm	17 mm	17 mm	40	2004171
HSA-F M12 20/5/-	12 mm	M12	100 mm	14 mm	50 Nm	19 mm	19 mm	25	2004173
HSA-F M12 35/20/-	12 mm	M12	115 mm	14 mm	50 Nm	19 mm	19 mm	25	2004174
HSA-F M12 65/50/15	12 mm	M12	145 mm	14 mm	50 Nm	19 mm	19 mm	25	2004175
HSA-F M16 5/-/-	16 mm	M16	102 mm	18 mm	80 Nm	24 mm	24 mm	16	2004177
HSA-F M16 40/25/-	16 mm	M16	137 mm	18 mm	80 Nm	24 mm	24 mm	16	2004178
HSA-F M20 10/-/-	20 mm	M20	125 mm	22 mm	200 Nm	30 mm	30 mm	10	2036312
HSA-F M20 55/30/15	20 mm	M20	170 mm	22 mm	200 Nm	30 mm	30 mm	10	2036313

Standard stud anchor HSA-R2

Technical data

Material composition	Steel, A2 (SS 304)
Head configuration	Externally threaded
PROFIS	Yes



Base materials

- Concrete (uncracked)



Ordering designation	Drill bit diameter	Anchor size	Anchor length	Base plate clearance hole	Required tightening torque	Socket size	Wrench size	Sales pack quantity	Item number
HSA-R2 M8 20/10/-	8 mm	M8	70 mm	9 mm	15 Nm	13 mm	13 mm	100	2004218
HSA-R2 M10 20/10/-	10 mm	M10	83 mm	12 mm	25 Nm	17 mm	17 mm	50	2004219
HSA-R2 M12 20/5/-	12 mm	M12	100 mm	14 mm	50 Nm	19 mm	19 mm	25	2004220
HSA-R2 M12 35/20/-	12 mm	M12	115 mm	14 mm	50 Nm	19 mm	19 mm	25	2004221
HSA-R2 M16 40/25/-	16 mm	M16	137 mm	18 mm	80 Nm	24 mm	24 mm	16	2004222

Standard stud anchor HSA-R

Technical data

Material composition	Steel, A4 (SS316)
Head configuration	Externally threaded
PROFIS	Yes



Base materials

- Concrete (uncracked)



Ordering designation	Drill bit diameter	Anchor size	Anchor length	Base plate clearance hole	Required tightening torque	Socket size	Wrench size	Sales pack quantity	Item number
HSA-R M6 5/-/-	6 mm	M6	50 mm	7 mm	5 Nm	10 mm	10 mm	200	2036314
HSA-R M6 20/10/-	6 mm	M6	65 mm	7 mm	5 Nm	10 mm	10 mm	200	2036315
HSA-R M8 5/-/-	8 mm	M8	55 mm	9 mm	15 Nm	13 mm	13 mm	100	2004197
HSA-R M8 20/10/-	8 mm	M8	70 mm	9 mm	15 Nm	13 mm	13 mm	100	2004198
HSA-R M10 20/10/-	10 mm	M10	83 mm	12 mm	25 Nm	17 mm	17 mm	50	2004202
HSA-R M10 35/25/-	10 mm	M10	98 mm	12 mm	25 Nm	17 mm	17 mm	40	2004203
HSA-R M10 50/40/10	10 mm	M10	113 mm	12 mm	25 Nm	17 mm	17 mm	40	2004204
HSA-R M12 5/ -/-	12 mm	M12	85 mm	14 mm	50 Nm	19 mm	19 mm	25	2004207
HSA-R M12 20/5/-	12 mm	M12	100 mm	14 mm	50 Nm	19 mm	19 mm	25	2004208
HSA-R M12 35/20/-	12 mm	M12	115 mm	14 mm	50 Nm	19 mm	19 mm	25	2004209
HSA-R M12 65/50/15	12 mm	M12	145 mm	14 mm	50 Nm	19 mm	19 mm	25	2004210
HSA-R M16 5/-/-	16 mm	M16	102 mm	18 mm	80 Nm	24 mm	24 mm	16	2004214
HSA-R M16 20/5/-	16 mm	M16	117 mm	18 mm	80 Nm	24 mm	24 mm	16	2004215
HSA-R M16 40/25/-	16 mm	M16	137 mm	18 mm	80 Nm	24 mm	24 mm	16	2004216
HSA-R M16 85/70/30	16 mm	M16	182 mm	18 mm	80 Nm	24 mm	24 mm	16	2004217
HSA-R M20 10/-/-	20 mm	M20	125 mm	22 mm	200 Nm	30 mm	30 mm	10	2036317
HSA-R M20 55/30/15	20 mm	M20	170 mm	22 mm	200 Nm	30 mm	30 mm	10	2036318

Standard stud anchor HSV



Base materials

- Concrete (uncracked)

Applications

- Wide range of applications in uncracked concrete

Advantages

- Two embedment depths for a wide range of fastening thicknesses
- Setting mark for easy checking of correct installation depth
- Raised impact section prevents thread damage during installation
- Pre-assembled to save time

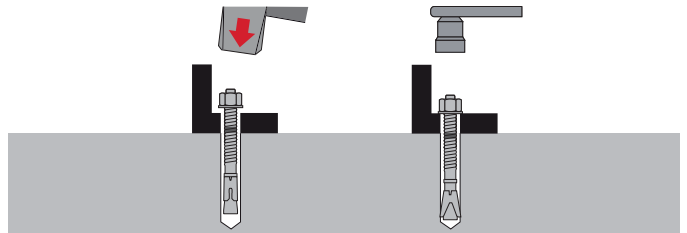

Technical data

Material composition	Steel, zinc-plated (min. 5 µm)
Head configuration	Externally threaded



Ordering designation	Drill bit diameter	Anchor size	Anchor length	Base plate clearance hole	Required tightening torque	Socket size	Wrench size	Sales pack quantity	Item number
HSV M8x75	8 mm	M8	75 mm	9 mm	15 Nm	13 mm	13 mm	100	2041604
HSV M10x90	10 mm	M10	90 mm	12 mm	30 Nm	17 mm	17 mm	50	2041605
HSV M12x100	12 mm	M12	100 mm	14 mm	50 Nm	19 mm	19 mm	30	2041607
HSV M12x150	12 mm	M12	150 mm	14 mm	50 Nm	19 mm	19 mm	25	2041610
HSV M16x120	16 mm	M16	120 mm	18 mm	100 Nm	24 mm	24 mm	16	2041611
HSV M16x140	16 mm	M16	140 mm	18 mm	100 Nm	24 mm	24 mm	16	2041612

Drop-in anchor HKD



Base materials

- Concrete (cracked)

Applications

- For medium-duty loads with anchor bolts and threaded rods, e.g. suspension systems for pipes, air ducts, sprinkler systems etc.
- For redundant fastening applications in cracked concrete or single-point applications in uncracked concrete

Advantages

- Features a lip for flush setting, regardless of hole depth
- Shallow drilling depth available in M6, M8, M10 and M12 sizes
- Visual check for correct setting when used with the Hilti setting tool

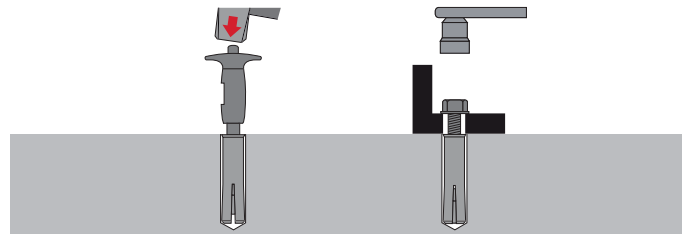

Drop-in anchor HKD

Technical data

Head configuration	Inner thread
Material composition	Steel, zinc-plated (min. 5 µm)
PROFIS	Yes
Suitable for cracked concrete with redundant fastenings	Yes



Anchor Systems

Ordering designation	Drill bit diameter	Drilling depth	Internal thread size	Useable thread length	Max. tightening torque	Packaging	Anchor length	Sales pack quantity	Item number
HKD M6x25	8 mm	27 mm	6 mm	13 mm	3 Nm	Box	25 mm	100	376894
HKD M8x30	10 mm	33 mm	8 mm	15 mm	7 Nm	Box	30 mm	100	376959
HKD M10x30	12 mm	33 mm	10 mm	14 mm	15 Nm	Box	30 mm	100	376965
HKD M10x40	12 mm	44 mm	10 mm	19 mm	15 Nm	Box	40 mm	50	376967
HKD M12x50	15 mm	55 mm	12 mm	23 mm	30 Nm	Box	50 mm	50	378544
HKD M16x65	20 mm	70 mm	16 mm	32 mm	60 Nm	Box	65 mm	25	382941
HKD M20x80	25 mm	85 mm	20 mm	44 mm	120 Nm	Box	80 mm	25	382955

Drop-in anchor (imperial) HKD

Technical data

Head configuration	Inner thread
Material composition	Steel, zinc-plated (min. 5 µm)
PROFIS	Yes



Base materials

- Concrete (uncracked)

Ordering designation	Drill bit diameter	Drilling depth	Internal thread size	Useable thread length	Max. tightening torque	Packaging	Anchor length	Sales pack quantity	Item number
HKD 1/4"x25	8 mm	27 mm	6 mm	13 mm	3 Nm	Box	25 mm	100	382980
HKD 5/16"x30	10 mm	33 mm	8 mm	15 mm	7 Nm	Box	30 mm	100	383679
HKD 3/8"x30	12 mm	33 mm	10 mm	14 mm	15 Nm	Box	30 mm	100	383686
HKD 3/8"x40	12 mm	44 mm	10 mm	19 mm	15 Nm	Box	40 mm	100	383960
HKD 1/2"x50	16 mm	55 mm	13 mm	23 mm	30 Nm	Box	50 mm	50	384021
HKD 5/8"x65	20 mm	70 mm	16 mm	32 mm	60 Nm	Box	65 mm	25	384023

Drop-in anchor HKD-SR

Technical data

Head configuration	Inner thread
Material composition	Steel, A4 (SS316)
PROFIS	Yes
Suitable for cracked concrete with redundant fastenings	Yes



Base materials

- Concrete (cracked)



Ordering designation	Drill bit diameter	Drilling depth	Internal thread size	Useable thread length	Max. tightening torque	Packaging	Anchor length	Sales pack quantity	Item number
HKD-SR M6X25	8 mm	27 mm	6 mm	12 mm	4 Nm	Box	25 mm	100	247951
HKD-SR M8X30	10 mm	33 mm	8 mm	15 mm	8 Nm	Box	30 mm	100	247952
HKD-SR M10X40	12 mm	43 mm	10 mm	18 mm	15 Nm	Box	40 mm	50	247953
HKD-SR M12X50	15 mm	54 mm	12 mm	22 mm	35 Nm	Box	50 mm	50	247954
HKD-SR M16X65	20 mm	70 mm	16 mm	31 mm	60 Nm	Box	65 mm	25	247955
HKD-SR M20X80	25 mm	85 mm	20 mm	42 mm	120 Nm	Box	80 mm	25	247956

Drop-in anchor (imperial) HKV



Base materials

- Concrete (uncracked)

Applications

- For medium-duty loads with anchor bolts and threaded rods, e.g. suspension systems for pipes, air ducts and sprinkler systems etc.

Advantages

- No collar - can be set at greater depth
- No damage to the thread when tapping in and expanding
- “Intelligent” stepped expansion piece adapts to suit materials of different hardness

Technical data

Head configuration	Inner thread
Material composition	Steel, zinc-plated (min. 5 µm)

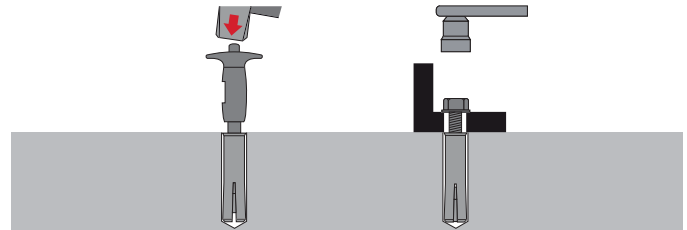

Ordering designation	Drill bit diameter	Drilling depth	Internal thread size	Useable thread length	Max. tightening torque	Packaging	Anchor length	Sales pack quantity	Item number
HKV 1/4"x25	8 mm	27 mm	6 mm	13 mm	3 Nm	Bag	25 mm	100	384975
HKV 5/16"x30	10 mm	33 mm	8 mm	15 mm	7 Nm	Bag	30 mm	100	384977
HKV 3/8"x30	12 mm	33 mm	10 mm	14 mm	15 Nm	Bag	30 mm	50	384979
HKV 3/8"x40	12 mm	44 mm	10 mm	19 mm	15 Nm	Bag	40 mm	50	384981
HKV 1/2"x50	16 mm	55 mm	13 mm	23 mm	30 Nm	Bag	50 mm	25	385456

Sleeve anchor HLC



Base materials

- Concrete (uncracked)
- Masonry (solid)

Applications

- Suitable for a large range of temporary applications, fastening small items etc.

Advantages

- Variety of lengths and sizes for a multitude of applications
- Pre-assembled anchor for fast, easy installation
- Suitable for various base materials thanks to the expansion principle
- Ideal for through-fastening applications
- The right drill bit diameter is printed on the sleeve - very practical
- Bulged sleeve middle section with diamond-shaped openings prevent the anchor spinning in the hole or dropping out when set overhead

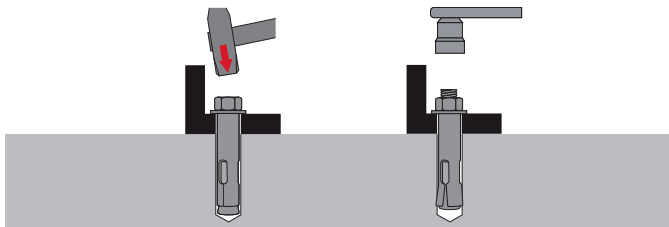

Technical data

Material composition	Steel, zinc-plated (min. 5 µm)
Head configuration	Hex head



Ordering designation	Anchor size	Drill bit diameter	Anchor length	Required tightening torque	Base plate clearance hole	Wrench/nut size	Wrench size	Sales pack quantity	Item number
HLC 6,5x25/5	5 mm	6.5 mm	25 mm	5 Nm	7 mm	8 mm	8 mm	100	385811
HLC 8x40/10	6 mm	8 mm	40 mm	8 Nm	10 mm	10 mm	10 mm	100	385814
HLC 8x55/25	6 mm	8 mm	55 mm	8 Nm	10 mm	10 mm	10 mm	100	385816
HLC 8x70/40	6 mm	8 mm	70 mm	8 Nm	10 mm	10 mm	10 mm	100	385817
HLC 10x40/5	8 mm	10 mm	40 mm	25 Nm	12 mm	13 mm	13 mm	50	385819
HLC 10x50/15	8 mm	10 mm	50 mm	25 Nm	12 mm	13 mm	13 mm	50	385820
HLC 10x60/25	8 mm	10 mm	60 mm	25 Nm	12 mm	13 mm	13 mm	50	385822
HLC 10x80/45	8 mm	10 mm	80 mm	25 Nm	12 mm	13 mm	13 mm	50	385823
HLC 12x55/15	10 mm	12 mm	55 mm	40 Nm	14 mm	15 mm	15 mm	50	385825
HLC 12x75/35	10 mm	12 mm	75 mm	40 Nm	14 mm	15 mm	15 mm	50	385827
HLC 12x100/60	10 mm	12 mm	100 mm	40 Nm	14 mm	15 mm	15 mm	25	385829
HLC 16x60/10	12 mm	16 mm	60 mm	50 Nm	18 mm	19 mm	19 mm	25	385830
HLC 16x100/50	12 mm	16 mm	100 mm	50 Nm	18 mm	19 mm	19 mm	10	385831
HLC 16x140/90	12 mm	16 mm	140 mm	50 Nm	18 mm	19 mm	19 mm	10	385832
HLC 20x80/25	16 mm	20 mm	80 mm	80 Nm	21 mm	24 mm	24 mm	10	385833
HLC 20x115/60	16 mm	20 mm	115 mm	80 Nm	21 mm	24 mm	24 mm	10	385834

Sleeve anchor HLV



Base materials

- Concrete (uncracked)
- Masonry (solid)

Applications

- Light and medium-duty fastenings in concrete
- Air conditioning and ventilation installations, telecoms, fastening electrical equipment, etc.
- Rails, rack systems, ladders, frames, formwork, fastening steel brackets/plates, etc.

Advantages

- Carbon steel grade 4.8, galvanised to min. 5 µm
- Easy installation
- Available in various sizes for maximized coverage of possible applications

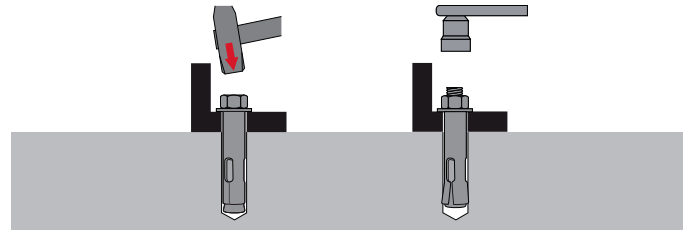

Technical data

Material composition	Steel, zinc-plated (min. 5µm)
Head configuration	Hex head

Ordering designation	Anchor size	Drill bit diameter	Anchor length	Required tightening torque	Base plate clearance hole	Wrench/nut size	Wrench size	Sales pack quantity	Item number
HLV 8x35/4	6 mm	8 mm	51	4 Nm	7 mm	10 mm	10 mm	100	432962
HLV 10x45/10	8 mm	10 mm	68	25 Nm	9 mm	13 mm	13 mm	100	432964
HLV 12x48/10	10 mm	12 mm	76	40 Nm	11 mm	15 mm	15 mm	50	432966
HLV 16x68/20	12 mm	16 mm	109	50 Nm	14 mm	19 mm	19 mm	50	432969

Frame anchor HRD-C



Base materials

- Concrete (aerated)
- Concrete (cracked)
- Concrete (hollow deck)
- Concrete (uncracked)
- Masonry (hollow)
- Masonry (solid)

Advantages

- Pre-assembled for optimum handling and fastening quality installation

Technical data

Material composition	Steel, zinc-plated (min. 5 µm), Polyamide
Head configuration	Countersunk
Type of fixing	Through-fastening

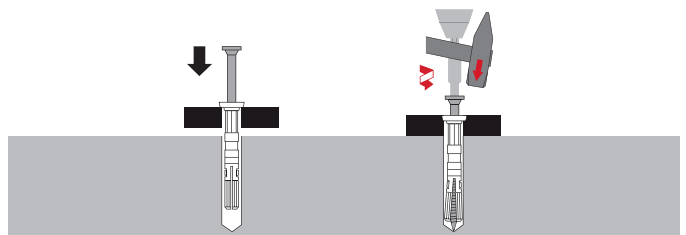

Ordering designation	Anchor size	Drill bit diameter	Fastening thickness at embed.2	Base plate clearance hole	Sales pack quantity	Item number
HRD-C 10x60	10 mm	10 mm		11 mm	50	423859
HRD-C 10x80	10 mm	10 mm	10 mm	11 mm	50	423860
HRD-C 10x100	10 mm	10 mm	30 mm	11 mm	50	423861
HRD-C 10x120	10 mm	10 mm	50 mm	11 mm	50	423862

Impact anchor HPS-1

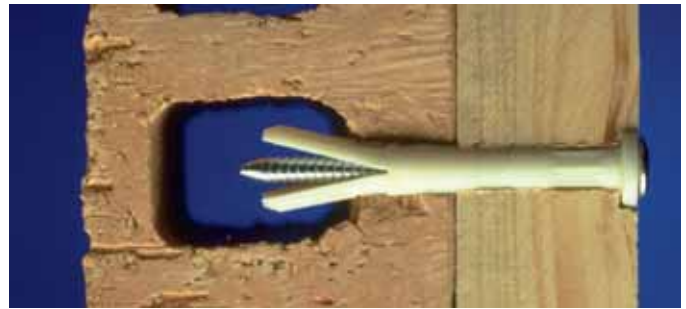

Base materials

- Concrete (aerated)
- Concrete (uncracked)
- Masonry (hollow)
- Masonry (solid)

Applications

- Anchoring concrete, brick ties and masonry
- Fastening components for electrical and plumbing installations
- Fastening trim strips, battens and components for electrical and plumbing installations

Advantages

- For universal use on many materials, including perforated brick and block
- The hammer-driven screw can also be driven or unscrewed using a screwdriver
- Quick impact installation using a hammer

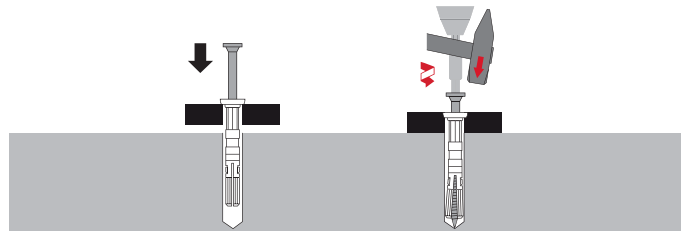

Technical data

Material composition	Body: polyamide, Screw: steel, zinc-plated (min. 5 µm)
Head configuration	Countersunk Phillips



Ordering designation	Drill bit diameter	Sales pack quantity	Item number
HPS-1 5/5X25	5 mm	200	260347
HPS-1 5/10X30	5 mm	200	230515
HPS-1 5/15X35	5 mm	200	260348
HPS-1 6/5X30	6 mm	150	260349
HPS-1 6/10X35	6 mm	150	260516
HPS-1 6/15X40	6 mm	150	260350
HPS-1 6/25X50	6 mm	100	260351
HPS-1 6/30X55	6 mm	100	230517
HPS-1 6/40X65	6 mm	100	260352
HPS-1 8/20X50	8 mm	50	230518
HPS-1 8/30X60	8 mm	50	260354
HPS-1 8/40X70	8 mm	50	230519
HPS-1 8/60X90	8 mm	50	260355
HPS-1 8/80X110	8 mm	50	260356

Universal plastic anchor HUD-1

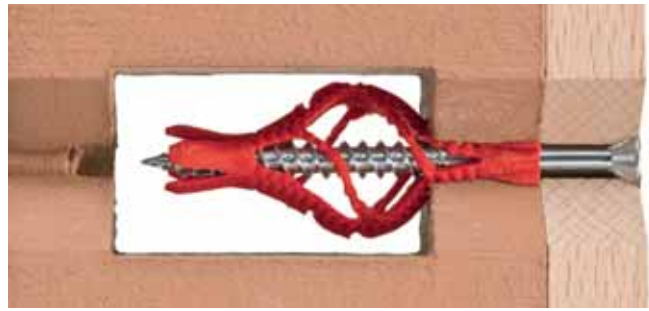

Base materials

- Concrete (aerated)
- Concrete (uncracked)
- Drywall
- Masonry (hollow)
- Masonry (solid)

Applications

- Many kinds of light-duty fastenings, especially electrical installations, sanitary fixtures, etc.

Advantages

- Base materials: concrete, solid brick, hollow brick, gas (aerated) concrete, gypsum panel
- High holding power
- Suitable for through-fastening with screw
- Resistance to turning in hole and premature expansion
- Reliable precise screw guidance, 360° expansion
- Meets safety specifications: contains no heavy metals, halogens or silicones

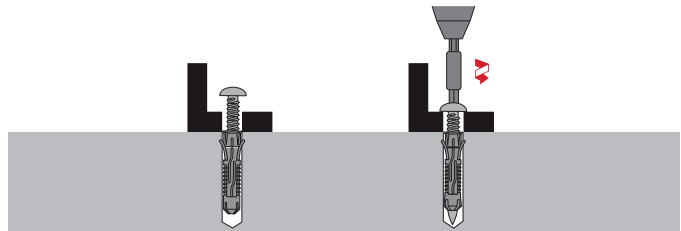

Technical data

Material composition	Polyamide PA 6
Head configuration	Countersunk Phillips, Countersunk Torx, Hex head, Round head, Flat head, Countersunk

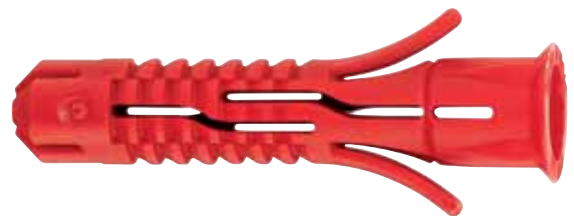

Ordering designation	Drill bit diameter	Anchor length	Screw diameter	Sales pack quantity	Item number
HUD-1 5x25	5 mm	25 mm	3.5-4 mm	500	331615
HUD-1 6x30	6 mm	30 mm	4.5-5 mm	500	331616
HUD-1 8x40	8 mm	40 mm	5-6 mm	400	331617
HUD-1 10x50	10 mm	50 mm	7-8 mm	200	331618
HUD-1 12x60	12 mm	60 mm	8-10 mm	100	331619

Cavity anchor HHD-S



Base materials

- Drywall
- Masonry (hollow)

Applications

- Securing support frames, timber frames for light stand-off cladding, facade panels

Advantages

- Pre-assembled screw
- Ergonomic setting tool for thread sizes M6
- Quick and trouble-free installation

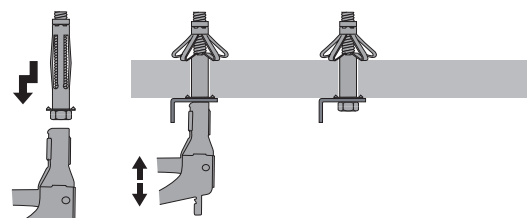

Technical data

Material composition	Steel, zinc-plated
Head configuration	Round head
Additional product information	With pre-assembled screw



Ordering designation	Anchor size	Drill bit diameter	Anchor length	Sales pack quantity	Item number
HHD-S M6/9X38	6 mm	12 mm	38 mm	100	332069
HHD-S M6/12X52	6 mm	12 mm	52 mm	50	332070
HHD-S M6/24X65	6 mm	12 mm	65 mm	50	332071
HHD-S M6/40X80	6 mm	12 mm	80 mm	50	332072

Light-duty anchor Kwik Tog HLD



Base materials

- Concrete (uncracked)
- Drywall
- Masonry (hollow)

Applications

- For fastening on low-strength materials with cavities. For use with standard wood screws
- Anchoring in perforated brick or block, drywall, concrete

Advantages

- The wings spring out and adapt to all materials
- Allows flexibility when selecting screws
- Ribs on body help prevent anchor from spinning during installation

Technical data

Material composition	Polyamide PA 6
Head configuration	Flat head, Round head
Anchor size	10 mm

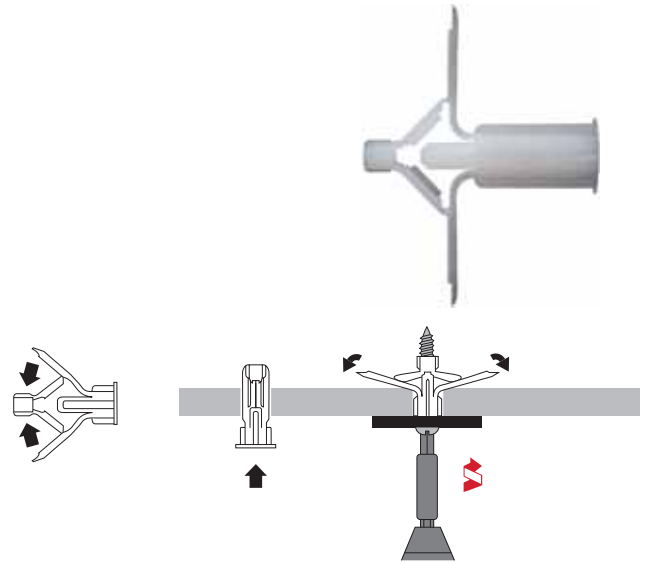

Ordering designation	Drill bit diameter	Drilling depth	Sales pack quantity	Item number
HLD 2	10 mm	50 mm	150	335506
HLD 3	10 mm	56 mm	100	335507
HLD 4	10 mm	66 mm	100	335508

Stop drill bit TE-C-HDA-B



SDS plus

Applications

- Special drill bit required for drilling HDA anchor holes with defined drilling depth



Technical data

Dispenser, setting tool, accessory, tester type	Stop drill bits
Insert connection end	TE-C (SDS-plus)

Ordering designation	Sales pack quantity	Item number
TE-C-HDA-B 20x100	1	332089
TE-C-HDA-B 20x120	1	332090
TE-C-HDA-B 22x125	1	402050
TE-C-HDA-B 22x155	1	402056
TE-C-HDA-B 22x175	1	402060

Stop drill bit TE-Y-HDA-B



SDS max

Applications

- Drilling HDA anchor holes to the defined depth

Advantages

- Achieves consistent drilled hole depth for proper installation of HDA undercut anchors



Technical data

Dispenser, setting tool, accessory, tester type	Stop drill bits
Insert connection end	TE-Y (SDS-max)

Ordering designation	Sales pack quantity	Item number
TE-Y-HDA-B 30x190	1	332097
TE-Y-HDA-B 30x230	1	332098
TE-Y-HDA-B 30x250	1	332099
TE-Y-HDA-B 37x250	1	339270
TE-Y-HDA-B 37x300	1	339271
TE-Y-HDA-B 37x350	1	339272

Setting tool TE-C-HDA-ST



SDS plus

Applications

- Setting tool required for the automatic self-undercutting operation with the HDA undercut anchor

Advantages

- Ensures fast, consistent and reliable setting of the HDA undercut anchor



Technical data

Dispenser, setting tool, accessory, tester type	Setting tools
Insert connection end	TE-C (SDS-plus)

Ordering designation	Sales pack quantity	Item number
TE-C-HDA-ST 20-M10	1	331843
TE-C-HDA-ST 22-M12	1	331844

Setting tool TE-Y-HDA-ST



SDS max

Applications

- Setting tool required for the automatic self-undercutting operation with the HDA undercut anchor

Advantages

- Ensures fast, consistent and reliable setting of the HDA undercut anchor



Technical data

Dispenser, setting tool, accessory, tester type	Setting tools
Insert connection end	TE-Y (SDS-max)

Ordering designation	Sales pack quantity	Item number
TE-Y-HDA ST 30-M16	1	331846
TE-Y-HDA-ST 37-M20	1	339269

Stop drill bit TE-C-HSC-B



SDS plus

Applications

- Special drill bit required for drilling HSC anchor holes with defined drilling depth



Technical data

Dispenser, setting tool, accessory, tester type	Stop drill bits
Insert connection end	TE-C (SDS-plus)

Ordering designation	Sales pack quantity	Item number
TE-C-HSC-B 14x40	1	31157
TE-C-HSC-B 14x50	1	31158
TE-C-HSC-B 16x40	1	28568
TE-C-HSC-B 18x50	1	30708
TE-C-HSC-B 18x60	1	30709
TE-C-HSC-B 20x60	1	30710

Setting tool TE-C-HSC-MW



SDS plus

Applications

- Setting tool required for the HSC safety anchor automatic self-undercutting operation



Technical data

Dispenser, setting tool, accessory, tester type	Setting tools
Insert connection end	TE-C (SDS-plus)

Ordering designation	Sales pack quantity	Item number
TE-C-HSC-MW14	1	31169
TE-C-HSC-MW16	1	11267
TE-C HSC-MW18	1	71352
TE-C-HSC-MW20	1	71353

Torque bar S-TB



Applications

- For setting HSA stud anchors with maximum accuracy and productivity

Advantages

- No more over or undertorquing of HSA stud anchors

Technical data

Base material	Concrete (uncracked)
Connection end size	12.7 mm
Drive connection	1/2 in square, female

Ordering designation	Sales pack quantity	Item number
S-TB HSA M8	1	423774
S-TB HSA M10	1	423775
S-TB HSA M12	1	423776
S-TB HSA M16	1	423777

Manual setting tool HSD-G



Applications

- Manual setting tool with hand guard for HKD and HKV drop-in anchor.

Technical data

Dispenser, setting tool, accessory, tester type	Setting tools
--	---------------

Ordering designation	Sales pack quantity	Item number
HSD-G M6 1/4"X25	1	243738
HSD-G M8 5/16"X30	1	243740
HSD-G M10 3/8"X30	1	230935
HSD-G M10 3/8"X40	1	243742
HSD-G M12 1/2"X50	1	243743
HSD-G M16 5/8"X65	1	243744
HSD-G M20 3/4"X80	1	243745

Setting tool HHD



Applications

- Setting tool for HHD-S cavity anchors

Technical data

Dispenser, setting tool, accessory, tester type	Setting tools
--	---------------

Ordering designation	Sales pack quantity	Item number
Setting tool HHD-S	1	332076

Anchor channel HAC-30



Base materials

- Concrete (cracked)
- Concrete (uncracked)

Applications

- Installation of building services in the basement backbone, risers and backbones for each level
- Floor or ceiling grid systems for applications with demanding requirements in terms of flexibility and dust or noise reduction e.g. semiconductor manufacturing or showrooms
- Main runs of pipes or ducts for heating, plumbing, ventilation and air conditioning

Advantages

- Serrated channel is compatible with Hilti MQ41 installation components
- Faster installation of building services than with traditional anchor fastening methods
- Dustless and noiseless fastening method

Technical data

Anchor type	Anchor channel
Material, corrosion	Steel, sherardized / hot-dip galvanized
Width	41 mm
Height	26 mm

Ordering designation	Length	Number of anchors	Anchor distance	Sales pack quantity	Item number
HAC-30 68/200 F	200 mm	2	150 mm	1	431889
HAC-30 68/250 F	250 mm	2	200 mm	1	431890
HAC-30 68/300 F	300 mm	2	250 mm	1	431891
HAC-30 68/550 F	550 mm	3	250 mm	1	431892

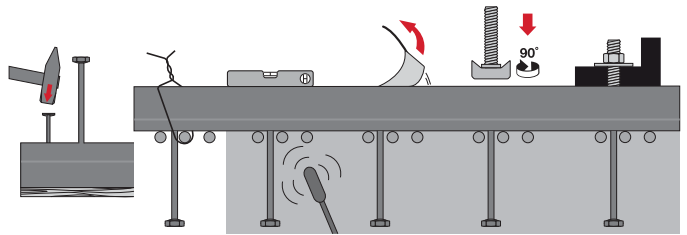
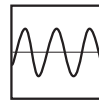

Anchor channel HAC-40



Base materials

- Concrete (cracked)
- Concrete (uncracked)

Applications

- Fastening curtain wall brackets
- Fastening guide rails for elevators and counterweights
- Fastening sliding door mechanisms for elevators

Advantages

- Innovative V-shape provides high load resistance and close edge distances
- New type of protective, environmentally friendly foam insert (LDPE) and end caps seal the channel effectively, preventing concrete slurry from entering the channel
- Foam insert features tear-out strip for trouble-free removal (avoids damage to the channel through use of drill bits, hammers or gas torches)

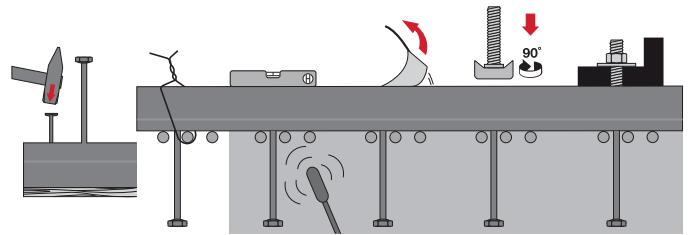
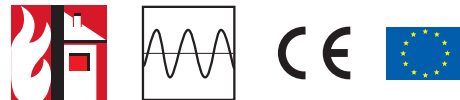

Technical data

Anchor type	Anchor channel
Material, corrosion	Steel, sherardized / hot-dip galvanized
Width	41 mm
Height	28 mm

Ordering designation	Length	Number of anchors	Anchor distance	Sales pack quantity	Item number
HAC-40 91/200 F	200 mm	2	150 mm	1	431906
HAC-40 91/250 F	250 mm	2	200 mm	1	431907
HAC-40 91/300 F	300 mm	2	250 mm	1	431908
HAC-40 91/350 F	350 mm	3	150 mm	1	431909
HAC-40 91/450 F	450 mm	3	200 mm	1	431910
HAC-40 91/550 F	550 mm	3	250 mm	1	431911

Anchor channel HAC-50



Base materials

- Concrete (cracked)
- Concrete (uncracked)

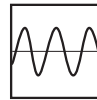

Applications

- Fastening curtain wall brackets
- For the installation of guide rails and doors in elevator installation
- Fastening guide rails for elevators and counterweights

Advantages

- Innovative V-shape provides high load resistance and close edge distances
- New type of protective, environmentally friendly foam insert (LDPE) and end caps seal the channel effectively, preventing concrete slurry from entering the channel
- Foam insert features tear-out strip for trouble-free removal (avoids damage to the channel through use of drill bits, hammers or gas torches)

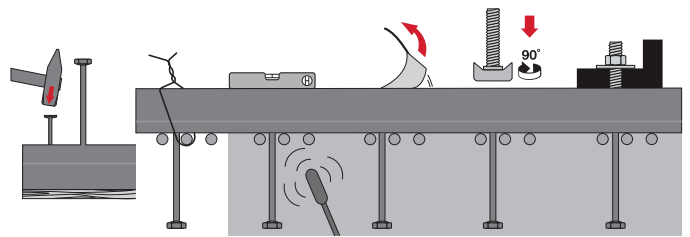

Technical data

Anchor type	Anchor channel
Material, corrosion	Steel, sherardized / hot-dip galvanized
Width	42 mm
Height	31 mm

Ordering designation	Length	Number of anchors	Anchor distance	Sales pack quantity	Item number
HAC-50 106/250 F	250 mm	2	200 mm	1	431836
HAC-50 106/300 F	300 mm	2	250 mm	1	431837
HAC-50 106/350 F	350 mm	3	150 mm	1	431838
HAC-50 106/450 F	450 mm	3	200 mm	1	431839
HAC-50 106/550 F	550 mm	3	250 mm	1	431840

Anchor channel HAC-60



Base materials

- Concrete (cracked)
- Concrete (uncracked)

Applications

- Fastening curtain wall brackets
- For the installation of guide rails and doors in elevator installation
- Fastening guide rails for elevators and counterweights

Advantages

- Innovative V-shape provides high load resistance and close edge distances
- New type of protective, environmentally friendly foam insert (LDPE) and end caps seal the channel effectively, preventing concrete slurry from entering the channel
- Foam insert features tear-out strip for trouble-free removal (avoids damage to the channel through use of drill bits, hammers or gas torches)

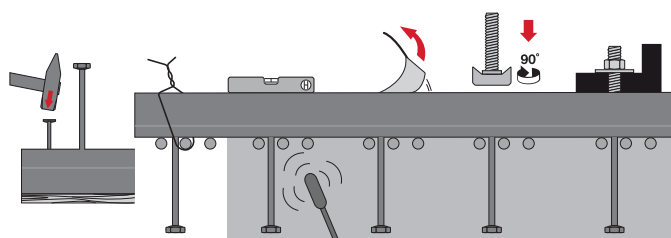
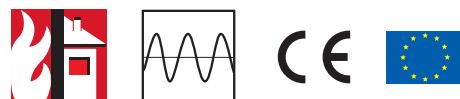

Technical data

Anchor type	Anchor channel
Material, corrosion	Steel, sherardized / hot-dip galvanized
Width	43 mm
Height	36 mm

Ordering designation	Length	Number of anchors	Anchor distance	Sales pack quantity	Item number
HAC-60 148/300 F	300 mm	2	250 mm	1	431850
HAC-60 148/350 F	350 mm	3	150 mm	1	431851
HAC-60 148/450 F	450 mm	3	200 mm	1	431852
HAC-60 148/550 F	550 mm	3	250 mm	1	431853

Anchor channel HAC-70



Base materials

- Concrete (cracked)
- Concrete (uncracked)

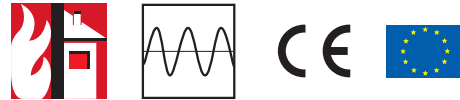

Applications

- Fastening curtain wall brackets
- Fastening guide rails for elevators and counterweights
- Fastening sliding door mechanisms for elevators

Advantages

- Innovative V-shape provides high load resistance and close edge distances
- New type of protective, environmentally friendly foam insert (LDPE) and end caps seal the channel effectively, preventing concrete slurry from entering the channel
- Foam insert features tear-out strip for trouble-free removal (avoids damage to the channel through use of drill bits, hammers or gas torches)

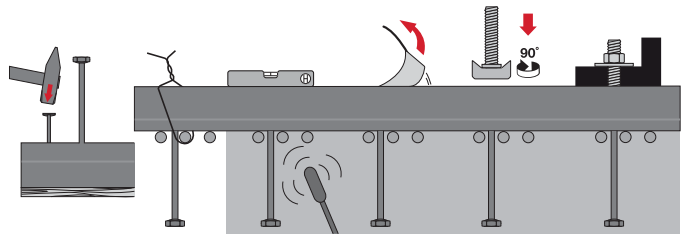

Technical data

Anchor type	Anchor channel
Material, corrosion	Steel, sherardized / hot-dip galvanized
Width	45 mm
Height	40 mm

Ordering designation	Length	Number of anchors	Anchor distance	Sales pack quantity	Item number
HAC-70 175/300 F	300 mm	2	250 mm	1	431860
HAC-70 175/350 F	350 mm	3	150 mm	1	431861
HAC-70 175/450 F	450 mm	3	200 mm	1	431862
HAC-70 175/550 F	550 mm	3	250 mm	1	431863

T-head bolt (galvanized) HBC-B



Applications

- For use with HAC-30 anchor channels

Advantages

- Dustless, low-noise fastening method
- European approval in accordance with the latest technical specifications

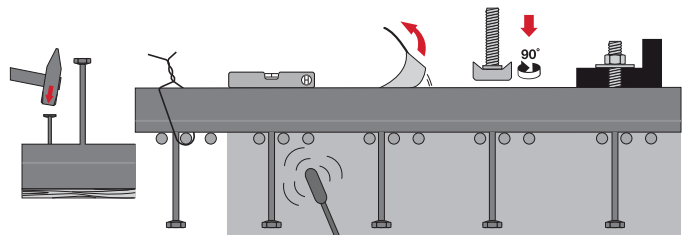
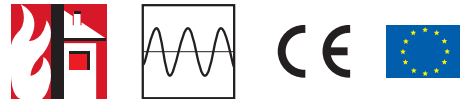

Technical data

Anchor type	T-head bolt
Material, corrosion	Steel, zinc-plated

Ordering designation	Sales pack quantity	Item number
HBC-B M10x40 4.6G	100	433527
HBC-B M10x60 4.6G	100	433528

T-head bolt (hot-dip galvanized) HBC-B



Applications

- For use with HAC-30 anchor channels

Advantages

- Dustless, low-noise fastening method
- European approval in accordance with the latest technical specifications

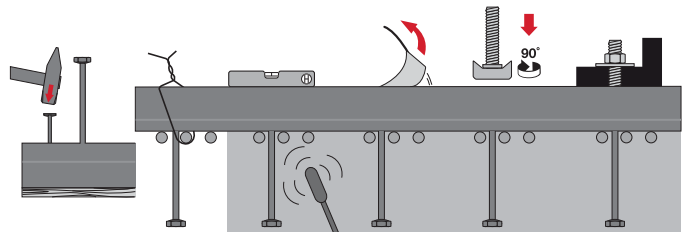
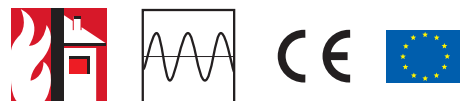

Technical data

Anchor type	T-head bolt
Material, corrosion	Steel, sherardized / hot-dip galvanized

Ordering designation	Sales pack quantity	Item number
HBC-B M12x40 4.6F	100	433534
HBC-B M12x60 4.6F	100	433535

Anchor Systems

T-head bolt (galvanized) HBC-C

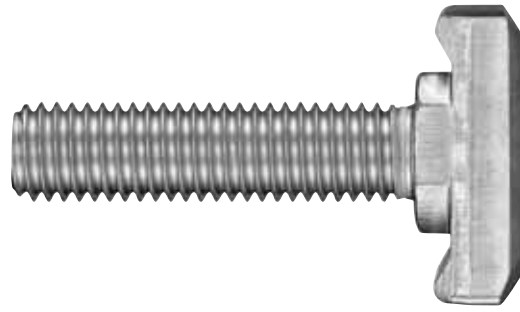

Applications

- For use with HAC-40 to HAC-70 anchor channels

Advantages

- Dustless and noiseless fastening method
- Simplification of the range available. Only one universal bolt type needed to cover HAC-40 to HAC-70 anchor channels
- European approval according to latest technical specifications

Technical data

Anchor type	T-head bolt
Material, corrosion	Steel, zinc-plated

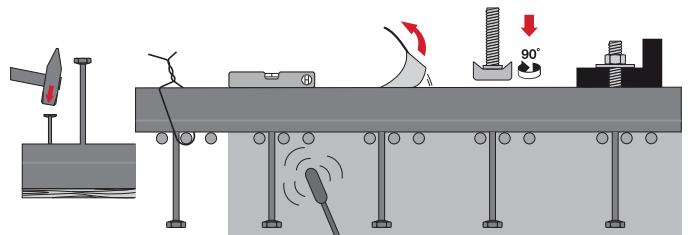
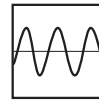

Ordering designation	Sales pack quantity	Item number
HBC-C M10x40 4.6G	100	434354
HBC-C M10x50 4.6G	100	434355
HBC-C M10x60 4.6G	100	434356
HBC-C M12x40 4.6G	100	434363
HBC-C M12x50 4.6G	100	434364
HBC-C M12x60 4.6G	100	434365
HBC-C M16x50 4.6G	100	434371
HBC-C M16x60 4.6G	100	434372
HBC-C M16x80 4.6G	50	434373
HBC-C M16x50 8.8G	100	434378
HBC-C M16x60 8.8G	100	434379
HBC-C M16x70 8.8G	100	434380
HBC-C M16x80 8.8G	50	434381

T-head bolt (hot-dip galvanized) HBC-C



Applications

- For use with HAC-40 to HAC-70 anchor channels

Advantages

- Dustless and noiseless fastening method
- Simplification of the range available Only one universal bolt type needed to cover HAC-40 to HAC-70 anchor channels
- European approval according to latest technical specifications

Technical data

Anchor type	T-head bolt
Material, corrosion	Steel, sherardized / hot-dip galvanized

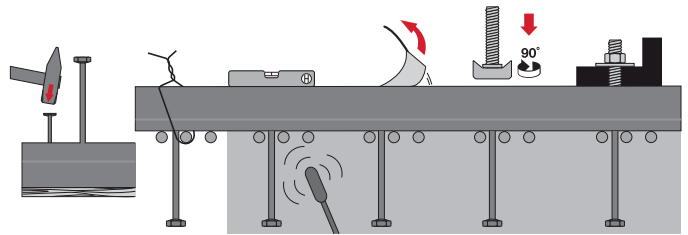
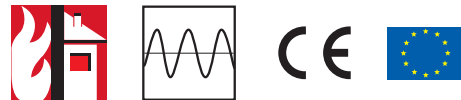

Ordering designation	Sales pack quantity	Item number
HBC-C M10x30 4.6F	100	434383
HBC-C M10x60 4.6F	100	434384
HBC-C M12x40 4.6F	100	434386
HBC-C M12x50 4.6F	100	434387
HBC-C M12x60 4.6F	100	434388
HBC-C M16x50 4.6F	100	434391
HBC-C M16x60 4.6F	100	434392
HBC-C M16x70 4.6F	100	434393
HBC-C M16x80 4.6F	50	434394
HBC-C M20x60 4.6F	50	434397
HBC-C M20x80 4.6F	50	434398
HBC-C M20x100 4.6F	50	434399
HBC-C M12x40 8.8F	100	434401
HBC-C M12x50 8.8F	100	434402
HBC-C M12x60 8.8F	100	434403
HBC-C M16x50 8.8F	100	434404
HBC-C M16x60 8.8F	100	434405
HBC-C M16x80 8.8F	50	434406
HBC-C M20x60 8.8F	50	434408
HBC-C M20x80 8.8F	50	2019735
HBC-C M20x100 8.8F	50	434409

T-head bolt (stainless steel) HBC-C

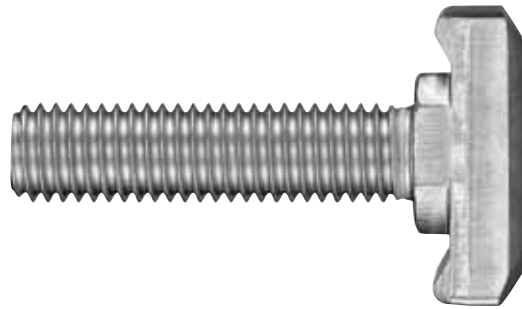

Applications

- For use with HAC-40 to HAC-70 anchor channels

Advantages

- Simplification of the range available. Only one universal bolt type needed to cover HAC-40 to HAC-70 anchor channels
- European approval according to latest technical specifications
- Dustless and noiseless fastening method

Technical data

Anchor type	T-head bolt
Material, corrosion	Steel, stainless

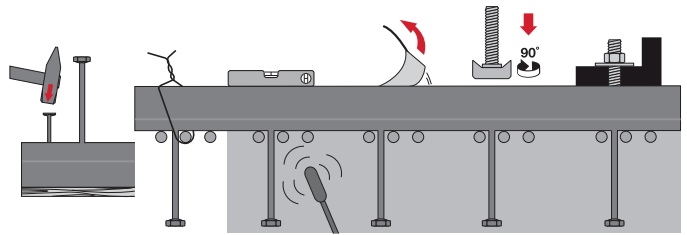
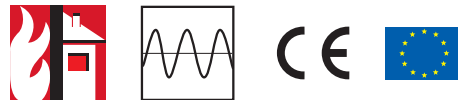

Ordering designation	Sales pack quantity	Item number
HBC-C M10x30 50R	50	433459
HBC-C M10x40 50R	25	433460
HBC-C M10x50 50R	25	433461
HBC-C M12x40 50R	25	433463
HBC-C M12x50 50R	25	433465
HBC-C M12x80 50R	25	433466
HBC-C M16x50 50R	50	433471
HBC-C M16x60 50R	50	433472
HBC-C M16x80 50R	25	433474

T-head bolt (galvanized) HBC-C-E

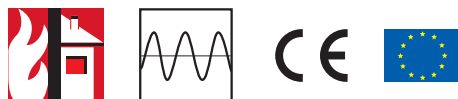
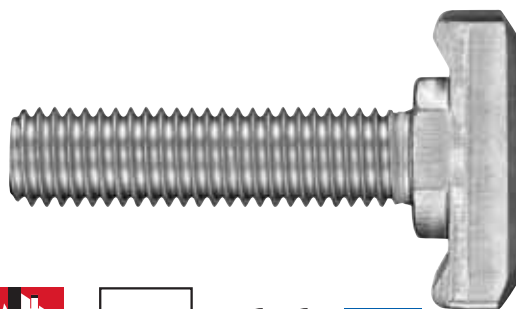

Applications

- Special geometry for elevator applications
- For use with HAC-40 to HAC-70 anchor channels

Advantages

- Simplification of the available range. Only one universal bolt type needed to cover HAC-40 to HAC-70 anchor channel
- Dustless, low-noise fastening method
- European approval in accordance with the latest technical specifications

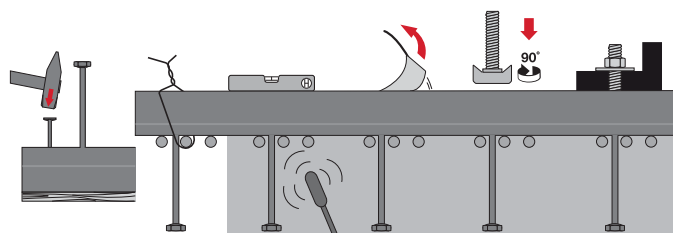

Ordering designation	Sales pack quantity	Item number
HBC-C-E M12x40 8.8G	100	433538
HBC-C-E M12x50 8.8G	100	433539
HBC-C-E M12x60 8.8G	100	433540
HBC-C-E M16x50 8.8G	100	433543
HBC-C-E M16x60 8.8G	100	434347
HBC-C-E M16x80 8.8G	50	434348

T-head bolt (hot-dip galvanized) HBC-C-N



Applications

- For use with HAC-40 to HAC-70 anchor channels

Advantages

- Simplification of the available range. Only one universal bolt type needed to cover HAC-40 to HAC-70 anchor channel
- Toothed bolts for reliable load transfer in a longitudinal direction
- Dustless, low-noise fastening method

Technical data

Anchor type	T-head bolt
Material, corrosion	Steel, sherardized / hot-dip galvanized

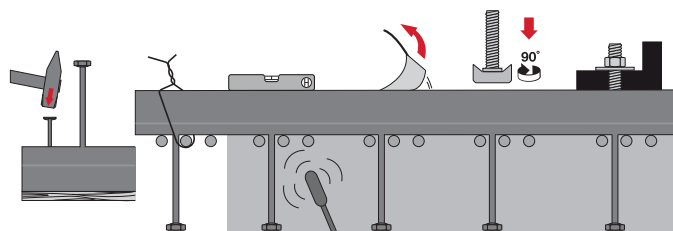

Ordering designation	Sales pack quantity	Item number
HBC-C-N M16x50 8.8F	100	433478
HBC-C-N M16x60 8.8F	100	2019736
HBC-C-N M16x80 8.8F	50	433479
HBC-C-N M20x60 8.8F	50	434345
HBC-C-N M20x80 8.8F	50	2019739
HBC-C-N M20x100 8.8F	50	434346